

## Katun Products for use in

**Canon**

## Table of Contents

	<i>Page</i>
<b>Copy Machine Equivalency List</b> .....	i
<b>Descriptions of Katun Product Brands and Technologies</b> .....	v
<b>Beschreibungen der Produktmarken und Technologien von Katun</b> .....	vii
<b>Personalized Product Agreement</b> .....	ix
<b>Vereinbarung Über Bestellung Von Produkten Mit Ihrem Firmenetikett</b> .....	xi
<b>Bearings/Bushings</b> .....	1
<b>Belts</b> .....	8
<b>Blades/Brushes</b> .....	9
<b>Corona/Charge/Transfer</b> .....	11
<b>Electrical</b> .....	16
<b>Feed/Delivery</b> .....	17
<b>Filters</b> .....	30
<b>Fuser Cleaning</b> .....	31
<b>Fuser Oil</b> .....	34
<b>Gears</b> .....	35
<b>Kits</b> .....	36
<b>Lamps</b> .....	43
<b>Memory Upgrades</b> .....	44
<b>Miscellaneous</b> .....	45
<b>Photoreceptors</b> .....	46
<b>Picker Fingers</b> .....	51
<b>Rollers, Fuser/Heat</b> .....	53
<b>Rollers, Pressure</b> .....	56
<b>Seals</b> .....	58
<b>Springs</b> .....	59
<b>Thermal Control Devices</b> .....	60
<b>Toners/Toner Cartridges</b> .....	61
<b>General Information</b> .....	I
<b>Allgemeine Hinweise</b> .....	III
<b>Distributor Choice Warranty Claim Form</b> .....	V
<b>HÄNDLER-GARANTIEFORMULAR</b> .....	VII



## Copy Machine Equivalency List

Central/Eastern Europe  
 Telephone: 31(0)183-696969  
 Fax: 31(0)183-629055  
 E-mail: order@edc.katun.com

Canon	Agfa	CPF	Danka Office Imaging (Kodak)	Olivetti Lexikon
CLC 1		CANON CLC		
CLC 10				COLOR 8000
CLC 200		CANON CLC 200		
CLC 300	XC 305	CANON CLC 300		
CLC 320	XC 307			
CLC 350	XC 315	CANON CLC 350		
CLC 500		CANON CLC 500		
CLC 550		CANON CLC 550		
CLC 700	XC 707			
CLC 700 E	XC 707			
CLC 700 L	XC 707			
CLC 700 S	XC 707			
CLC 800	XC 907			
CLC 800 S	XC 907			
CLC 900	XC 717		DANKA C 1600	
CLC 950	XC 917		DANKA C 1650	
CLC 1000			DANKA C 2000	
			KODAK 2000	
CLC 1000 S			DANKA C 1900	
CLC 1130			DANKA C 1700	
CLC 1150			DANKA C 1750	
CLC 1180			ISC 1142	
CLC 5000			IC 5000	
FC 1				COPIA 7012
FC 2				COPIA 7014
FC 5				COPIA 7005
FC 22				COPIA 7014
FC 220				COPIA 9004
				COPIA 9404
FC 230				COPIA 8004
FC 330				COPIA 8006
GP 55		CANON GP 55		
GP 55 F		CANON GP 55		
GP 55 II		CANON GP 55		
GP 160				COPIA 9916
GP 160 F				COPIA 9916 F
IMAGERUNNER 110 M			Digisource 9110	
iR 110			Digisource 9110	
iR 5000			IS 1050	
iR 6000			IS 1060	
NP 115		GAMMA		
NP 150		DELTA		COPIA 7045
NP 155				COPIA 7046
NP 1010		CANON NP 1010		COPIA 7025
NP 1015		CANON NP 1015		COPIA 7039
NP 1020		CANON NP 1020		
NP 1215		CANON NP 1215		COPIA 7041
NP 1318		CANON NP 1318		COPIA 7047
NP 1510		CANON NP 1510		COPIA 7139
NP 1520		CANON NP 1520		COPIA 7141
NP 1530		CANON NP 1530		COPIA 8015
NP 1550		CANON NP 1550		COPIA 8515
NP 1812				COPIA 7020
				COPIA 7024

## Copy Machine Equivalency List

Canon	Agfa	CPF	Danka Office Imaging (Kodak)	Olivetti Lexikon
NP 2010		CANON NP 2010		COPIA 7147
NP 2020		CANON NP 2020		COPIA 8521
NP 3025		CANON NP 3025		
NP 3030		CANON NP 3030		COPIA 8130
NP 3050		CANON NP 3050		COPIA 8030
NP 3225		CANON NP 3225		
NP 3325		CANON NP 3325		COPIA 7052
NP 3525		CANON NP 3525		COPIA 7055
NP 3725		CANON NP 3725		COPIA 7056
NP 3825		CANON NP 3825		COPIA 7054
NP 3825 II		CANON NP 3825 II		
NP 4040		CANON NP 4040		COPIA 7065
NP 4050		CANON NP 4050		COPIA 8040
NP 4080		CANON NP 4080		COPIA 8540
NP 4335		CANON NP 4335		COPIA 7062
NP 4540				COPIA 7066
NP 4835		CANON NP 4835		
NP 4835 i		CANON NP 4835 I		COPIA 7064
NP 5060		CANON NP 5060		COPIA 8050
NP 6010				COPIA 8010
NP 6012				COPIA 8012
NP 6016				COPIA 8021
NP 6020				COPIA 8020
NP 6025				COPIA 8025
NP 6028				COPIA 8028
NP 6030		CANON NP 6030		COPIA 8530
NP 6035				COPIA 8035
NP 6035 F				COPIA 8035
NP 6045				COPIA 8045
NP 6050				COPIA 8550
NP 6050 ER				COPIA 8550
NP 6060		CANON NP 6060		
NP 6085	X 820			
NP 6112				COPIA 8512
NP 6116				COPIA 8016
NP 6216				COPIA 8516
NP 6220				COPIA 8520
NP 6241				COPIA 8041
NP 6251				COPIA 9051
NP 6260				COPIA 9060
NP 6317				COPIA 9017
NP 6320				COPIA 9020
NP 6360				COPIA 9060
NP 6621				COPIA 9021
NP 6650		CANON NP 6650		COPIA 7170
NP 6825 DADF		CANON NP 3325		COPIA 7052
NP 6826 DADF		CANON NP 3825		COPIA 7054
NP 6831		CANON NP 3050		COPIA 8030
NP 6835 RDF		CANON NP 4335		COPIA 7062
NP 6850		CANON NP 5060		COPIA 8050
NP 6880		CANON NP 8580		
NP 6885	X 800	CANON NP 8530		
NP 7050		CANON NP 7050		

## Copy Machine Equivalency List

Central/Eastern Europe  
 Telephone: 31(0)183-696969  
 Fax: 31(0)183-629055  
 E-mail: order@edc.katun.com

Canon	Agfa	CPF	Danka Office Imaging (Kodak)	Olivetti Lexikon
NP 7550		CANON NP 7550		
NP 8070		CANON NP 8070		
NP 8530	X 800	CANON NP 8530		
NP 8570		CANON NP 8570		
NP 8580		CANON NP 8580		
NP 9330		CANON NP 9330		
NP 9800	X 805	CANON NP 9800		
NP 9850		CANON NP 9850	KODAK 2085	
PC 20				COPIA 7010
PC 25				COPIA 7015
ADF- 4		CANON ADF- 4		ADF- 4
ADF- A1		CANON ADF- A1		ADF- 8521
ADF- C1				ADF- 8530
ADF- E1				ADF- 8021
ADF- H1				ADF- 9916
AF- 1		CANON AF- 1		
AUTO STAP/FOLD- 1		AUTO STAP /FOLD -1		AUTO STAP/FOLD- 1
AUTO STAP/FOLD- 2		AUTO STAP /FOLD -2		AUTO STAP/FOLD- 2
AUTO STAP/FOLD- A1				FINISHER- 8030
AUTO STAPLER- AS1		AUTO STAPLER AS- 1	AUTO STAPLER- AS1	
CFF- A1	CFF- A1	CANON CFF- A1	EK 95 CFF	
CFF- A2	CFF- A2			
CFU- A1				LCT- 8021
CFU- A2				CFU- A2
CFU- C1	CFU- C1			CFU- 8021
CFU- D1		CANON CFU- D1		LCT- 8030
CFU- E1		CANON CFU- E1		CFU- E1
CFU- F1				CFU- F1
CFU- G1				DLCT- 8530
CFU- H1				LCT- 8530
CFU- N1				CP- 8530
ColorPASS- Z40			FIERY NX- 40	
ColorPASS- Z60			FIERY NX- 60	
ColorPASS- Z90			FIERY NX- 90	
ColorPass- Z5000			FIERY PS NX- Z5000	
D- ADF				D-ADF
DADF- D1			DADF- D1	
DF- 4		CANON DF- 4		DF- 4
DF- 5		CANON DF- 5		DF- 5
DU- A1				DU- 8530
FILM PROJECT CLC 200			FILM PROJECTOR 1525	
FINISHER- F1			FINISHER- F1	
MS- A1				SRT- 2 7139
NAGEL FINISHER			NAGEL FINISHER FN5	
PD- 3		CANON PD- 3		PD- 3
PD- 4		CANON PD- 4		
PD- 5		CANON PD- 5		PD- 5
PD- 6		CANON PD- 6		PD- 6
PD- 8		CANON PD- 8		PD- 8
PD- J1			PD- J1	
PD- K1			PD- K1	
PDP- A1				SLCT- 9051
PDP- B1				DU- 8035

## Copy Machine Equivalency List

Canon	Agfa	CPF	Danka Office Imaging (Kodak)	Olivetti Lexikon
PDP- C1		CANON PD- C1		LCT- 8521
PDP- D1		CANON PD- D1		3K- LCT
PDP- E1		CANON PD- E1	EK 30 LCC	PDP- E1
PDP- J1				LCT- 8020
PDP- K1				PDP- K1
RDF- 1		CANON RDF- 1		RDF- 1
RDF- 2		CANON RDF- 2		RDF- 2
RDF- 3	RDF- 3	CANON RDF- 3		
RDF- A1	RDF- A1	CANON RDF- A1		
RDF- B1		CANON RDF- B1	EK 30 FEEDER	RDF- 8021
RDF- C1				RDF- 8530
RDF- D1	RDF- D1		IS 50 FEEDER	RDF- 8550
RDF- E1	RDF- E1			
RDF- E3			RDF- E3	
RDF- F1				RDF- F1
RF- B1		RF- B1		RF- B1
SADDLE FINISHER F2			SADDLE FINISHER F2	
SLIDE PROJECTO CLC 1		CANON SLID PROJ. CLC		
SORTER- V		CANON SORTER- V		SORTER- V
SORTER- B1	SRT- 20B	CANON SORTER- B1		SORTER- B1
				SRT- 20 8550
				SRT- 20 8530
SORTER- C1				
SORTER- D1	SORTER- D1			
SORTER- E1				SRT- 20 8035
SORTER- IV		CANON SORTER- IV		
STAPLER SORTER		CANON STAPLER/ SORT.		S- SRT 20
STAPLER SORTER- A1	STS- 20B	CANON STAP SORT. -A1		SSRT- 20 8030
				SSRT- 20 8045
STAPLER SORTER- B1		CANON STAP SORT. -B1		STAPLER/SORTER- B1
STAPLER SORTER- C1				SSRT- 20
STAPLER SORTER- D1				SSRT- 10
				STAPLER/SORTER- D1
STAPLER SORTER- E1				STAPLER SORTER- E1
STAPLER SORTER- E2	STAPLER SORTER- E2		STAPLER SORTER- E2	S-SRT- 20 9051

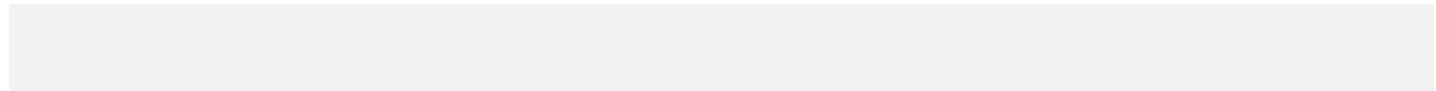
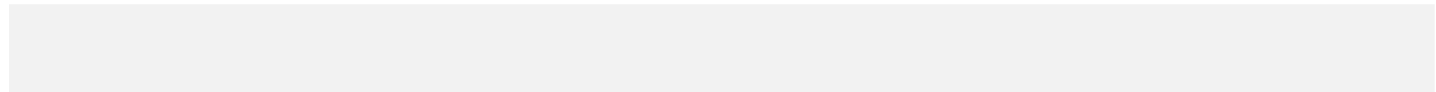
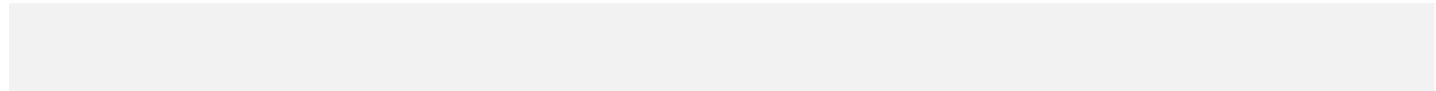

## Descriptions of Katun Product Brands and Technologies

### Katun Performance Products

Katun Performance is our complete line of office automation products that combine our highest quality level with consistent, reliable performance and competitive pricing - and provide excellent overall value.

Katun Performance products meet strict quality guidelines and have been 100% tested and approved according to the Katun 360° Certification process, which includes environmental testing, forward and reverse compatibility testing, model application testing, and component compatibility testing. In addition, all Katun Performance products are warranted to be free from functional defects in material and workmanship for one year and come with the highest level of Katun technical support.

To locate Katun Performance products, look for the Katun Performance icon  throughout this catalog.

### Access by Katun Products

Access by Katun is a line of selected products that address the unique pricing or product needs of specific markets. Access by Katun products provide market acceptable quality and market competitive pricing. The Access by Katun product line complements the Katun Performance line by providing a value proposition based primarily on specific market needs.

Access by Katun products come with a limited level of product support and a one-year warranty. Although Access by Katun products provide some price advantages, remember that Katun Performance products always provide excellent overall value.

### Original Products

Select OEM brand products that Katun offers to meet certain market needs

## Fuser Roller Coating Technologies

Minco Manufacturing, Inc., a wholly owned subsidiary of Katun Corporation, is a world-leading manufacturer of fuser rollers for use in plain paper copiers, facsimiles, and printers. The product development relationship between Katun, Minco, and DuPont, the exclusive manufacturer of genuine TEFLON<sup>®</sup> brand coatings, has produced numerous advanced fuser roller coating technologies, including:

**DURAPREM<sup>™</sup> II upper fuser rollers** are manufactured with a heat-resistant, nonstick TEFLON<sup>®</sup> brand coating that provides increased surface hardness for extended potential life. A proprietary finishing process produces an exceptionally smooth surface, which contributes to these rollers' excellent fusing performance and toner release in machines using negative-charge toner.

**DURACON<sup>™</sup> II upper fuser rollers** are manufactured with a heat-resistant, nonstick TEFLON<sup>®</sup> brand coating that includes patented conductive additives for static dissipation. These rollers provide excellent fusing performance, toner release, and long life, primarily in machines using positive-charge toner.

**ALUMANA<sup>™</sup> upper fuser rollers** are manufactured with extremely hard, tough primer and midcoat layers for maximum resistance to wear and abrasion. The ceramic ALUMANA coating combines a DuPont-patented polymer blend with reinforcing oxides for enhanced durability. These heavy-duty rollers are specifically designed to meet the demands of hostile fuser station environments and higher-speed machines using either positive-charge or negative-charge toner.

**TRITON<sup>™</sup> II upper fuser rollers** are manufactured with an advanced TEFLON<sup>®</sup> brand coating that provides improved fusing performance and nonstick characteristics in comparison to conventional fluoropolymer coatings. Unique static-dissipative particulates within the TRITON II coating, together with enhanced manufacturing processes, contribute to these rollers' superior abrasion-resistance and excellent toner release. These rollers provide extended potential life in selected machines using either positive-charge or negative-charge toner.

## Central/Eastern Europe

Telephone: 31(0)183-696969

Fax: 31(0)183-629055

E-mail: [order@edc.katun.com](mailto:order@edc.katun.com)

**TRITON BLUE™ upper fuser rollers** deliver excellent performance for machine applications that are tough on fuser rollers. Manufactured with an advanced TEFLON® brand coating that provides improved fusing performance and nonstick characteristics in comparison to conventional fluoropolymer coatings, TRITON BLUE™ fuser rollers combine improved wear resistance with superior abrasion-resistance and excellent toner release.

**TUF/SIL™ upper fuser rollers** are manufactured with a layer of silicone rubber that effectively regulates heat flow to the toner, plus an outermost layer that consists of a specially blended TEFLON® brand coating providing excellent toner release and abrasion-resistance. This combination ensures reduced toner offsetting and improved, more consistent copy quality under certain demanding machine usage conditions. These rollers provide a high-performance, cost-effective solution for selected machines required to consistently produce the best possible copy quality.

**MICROSLEEVE™ lower pressure rollers**, with nonstick PFA sleeves 50, 70, or 100 microns in thickness, provide excellent wear-resistance for improved copy quality over an extended life. A-Series MICROSLEEVE™ lower pressure rollers are designed specifically for machines utilizing lower fuser cleaning rollers. Their unique surface texture reduces toner buildup and improves cleaning efficiency within the fuser station.

All Katun fuser rollers are designed specifically for their intended applications and manufactured to exacting quality standards, ensuring their excellent performance and long life.

## Fuser Cleaning Roller Coating Technologies

Katun has introduced unique fuser cleaning roller technologies for machines requiring efficient removal and absorption of excess toner and contaminants, as well as continuous silicone oil lubrication of critical fuser station parts. For many machines, the ideal parts combination for achieving optimum copy quality and maximum parts life includes a specially designed Katun fuser cleaning roller.

**FIBRA™ fuser cleaning rollers** incorporate a uniform network of special fibers that aggressively remove excess toner and contaminants from the contacted surface. By efficiently depositing toner and contaminants beneath its outermost surface, the unique FIBRA network also helps maintain a continuous lubricative flow of silicone oil from the roller's internal tank to critical fuser station parts.

**FIBRA™ II fuser cleaning rollers** incorporate a unique configuration of highly heat-resistant fibers to greatly enhance cleaning performance, especially in hostile fuser station environments. Efficient absorption of excess toner and contaminants, together with continuous silicone oil lubrication of critical fuser station parts, effectively reduce parts and service expenses associated with the fuser station.

TEFLON® is a registered trademark of E.I. DuPont de Nemours and Company used under license by Katun Corporation.

## Personalized Product Program

Katun offers an extremely cost-effective way for office equipment dealers/distributors to ensure repeat business and strengthen relations with customers. The **Personalized Product program** enables dealers/distributors to provide high-quality Katun Performance imaging supplies (toner, fax and printer toner cartridges, digital duplicator inks and masters and thermal transfer ribbons) with their business name and /or logo, plus contact information, so end-users always know whom to call to reorder. For a one-time, nominal set-up fee, Katun designs and produces full-color labels to customer specifications and applies them to packaging at no extra charge. Only end-user-replaceable Katun Performance products are eligible under the program. Enrollment is simple and easy. Just complete the agreement form and submit it to your Katun sales representative or visit the Personalized Products page for more program and enrollment information.



## **Beschreibungen der Produktmarken und Technologien von Katun**

### **Katun Performance-Produkte**

Katun Performance ist unsere umfangreiche Produktreihe von Büromaschinenprodukten, die sich durch hohe Qualität sowie durch beständige, zuverlässige Leistung und attraktive Preise auszeichnen. Mit diesen Produkten soll der Nutzwert für den Kunden maximiert werden.

Katun Performance -Produkte erfüllen strenge Qualitätsstandards und wurden alle im Rahmen des 360° -Zertifizierungsverfahrens von Katun getestet und freigegeben. Die Produkte durchlaufen dabei Prüfungen der Umweltverträglichkeit, der Kompatibilität, der Modellanwendungen und der Komponentenkompatibilität. Darüber hinaus wird bei allen Katun Performance-Produkten ein Jahr lang gewährleistet, dass diese frei von funktionalen Material- und Verarbeitungsfehlern sind. Selbstverständlich steht Ihnen auch der hochwertige technische Support von Katun zur Verfügung.

**Um die Katun Performance-Produkte zu finden, halten Sie in diesem Katalog nach dem Namen Performance  und dem entsprechenden Symbol Ausschau.**

### **Originalprodukte**

Sie können verschiedene OEM-Produkte auswählen, die Katun aufgrund der Nachfrage auf dem Markt in sein Produktangebot aufgenommen hat.

### **Beschichtungstechnologien für Heizwalzen**

Minco Manufacturing Incorporated, eine hundertprozentige Tochtergesellschaft der Katun Corporation, ist einer der weltweit führenden Hersteller von Heizwalzen für Kopierer, Faxgeräte und Drucker. Die enge Zusammenarbeit zwischen Katun, Minco und DuPont, dem alleinigen Hersteller originaler TEFLON® - Beschichtungen, hat zur Entwicklung von zahlreichen neuartigen Beschichtungsmaterialien für Heizwalzen geführt:

**DURAPREM™ II** Heizwalzen sind mit einer temperaturbeständigen TEFLON® - Antihaf-Beschichtung ausgestattet und besitzen daher eine größere Oberflächenhärte für eine potenziell längere Lebensdauer. Die nach einem speziellen Finish-Verfahren hergestellte, außerordentlich glatte Walzenoberfläche bietet hervorragende Fixier- und Antihaf-Eigenschaften in Geräten mit negativ geladenem Toner.

**DURACON™ II** Heizwalzen sind mit einer temperaturbeständigen TEFLON® - Antihaf-Beschichtung ausgestattet, der patentierte, elektrisch leitfähige Inhaltsstoffe beigemischt sind, um das Ableiten von sich bildender statischer Ladung zu ermöglichen. Diese Heizwalzen zeichnen sich durch ihre hervorragenden Fixier- und Antihaf-Eigenschaften sowie eine lange Nutzungsdauer aus, besonders in Geräten mit positiv geladenem Toner.

**ALUMANA™** Heizwalzen besitzen eine äußerst harte, widerstandsfähige Grund- und Zwischenschicht für eine höchstmögliche Verschleißfestigkeit und Haltbarkeit. Die ALUMANA Keramiksicht beinhaltet eine patentierte Polymer-Mischung von DuPont mit Verstärkungsoxiden für eine erhöhte Widerstandsfähigkeit.

Diese robusten Heizwalzen sind speziell für anspruchsvolle Betriebsbedingungen in der Fixierstation und für schnellere Kopierer mit positiv oder negativ geladenem Toner konstruiert.

**TRITON™ II Heizwalzen** zeichnen sich durch ihre hochwertige TEFLON® -Beschichtung aus, die herkömmlichen Fluorpolymer-Beschichtungen in Bezug auf Fixier- und Antihaf-Eigenschaften überlegen ist. Spezielle antistatisch wirkende Partikel in der TRITON II-Beschichtung und hohe Fertigungsstandards tragen zu den ausgezeichneten Antihaf-Eigenschaften und der hervorragenden Verschleißfestigkeit dieser Heizwalzen bei.

Sie bieten potentiell längere Laufzeiten in ausgewählten Geräten sowohl mit positiv als auch mit negativ geladenem Toner.



## Central/Eastern Europe

Telephone: 31(0)183-696969

Fax: 31(0)183-629055

E-mail: [order@edc.katun.com](mailto:order@edc.katun.com)

**TUF/SIL™ Heizwalzen** besitzen eine Silikonbeschichtung, die für eine effiziente regulierte Wärmeableitung an den Toner sorgt, sowie eine besonders zusammengesetzte TEFLON® - Beschichtung mit ausgezeichneten Antihaft-Eigenschaften und hoher Verschleißfestigkeit. Dies führt zu weniger Toner-Offsetting-Problemen und gewährleistet auch unter anspruchsvollen Betriebsbedingungen eine gleichbleibend hohe Kopienqualität. Die TEFLON®/SILIKON Heizwalzen bieten ein sehr gutes Preis-/Leistungsverhältnis für ausgewählte Geräte, die höchste Qualitätsansprüche in Bezug auf die Kopienqualität stellen.

**MICROSLEEVE™** Presswalzen mit Antihaft-PFA-Ummantelung in den Stärken 50, 70 und 100 µm bieten eine außergewöhnliche Haltbarkeit und damit eine langfristig bessere Kopienqualität und längere Nutzungsdauer. Die Presswalzen der MICROSLEEVE™ A-Serie sind speziell für den Einsatz in Geräten gedacht, bei denen eine Reinigung der unteren Presswalze mittels Reinigungswalze stattfindet.

Ihre besondere Oberflächenstruktur reduziert Tonerablagerungen und verbessert die Reinigungswirkung in der Fixierstation.

Alle Heizwalzen von Katun wurden speziell im Hinblick auf deren Einsatzzweck entwickelt und erfüllen höchste Qualitätsstandards. Nicht umsonst zeichnen sie sich durch eine herausragende Leistung und eine lange Nutzungsdauer aus.

## Beschichtungstechnologien für Reinigungswalzen

Katun hat spezielle Reinigungswalzen für Geräte entwickelt, die eine wirksame Beseitigung von Tonerresten und Schmutz sowie eine kontinuierliche Versorgung wichtiger Teile der Fixierstation mit Silikonöl erfordern. Durch den Einsatz einer Katun Reinigungswalze kann bei vielen Geräten eine optimale Kopienqualität und eine größtmögliche Nutzungsdauer der Komponenten erzielt werden.

**FIBRA™** Reinigungswalzen entfernen Tonerreste und Schmutzpartikel durch ein spezielles Fasernetz effizient von der Walzenoberfläche. Während das FIBRA-Fasernetz die Verschmutzungen wirkungsvoll in seiner Oberfläche aufnimmt, sorgt es zugleich für eine Dauerversorgung wichtiger Teile der Fixierstation mit Silikonöl aus dem Vorratstank im Walzeninneren.

**FIBRA™II** Reinigungswalzen besitzen ein neuartiges, hitzebeständiges Fasernetz, mit denen besonders unter anspruchsvollen Betriebsbedingungen eine erheblich verbesserte Reinigungswirkung erzielt wird.

Durch die wirksame Aufnahme von Tonerresten und Schmutzstoffen bei gleichzeitiger Dauerversorgung wichtiger Teile in der Fixierstation mit Silikonöl können die Austausch- und Servicekosten für die Fixierstation erheblich gesenkt werden.

TEFLON® ist ein eingetragenes Warenzeichen von E.I. DuPont de Nemours and Company und wird von der Katun Corporation unter Lizenz verwendet.

## Firmenetiketten-Programm

Katun bietet Händlern einen äußerst kostengünstigen Weg, ihre Kunden an sich zu binden und Kundenbeziehungen zu verbessern. Das **Firmenetiketten-Programm** erlaubt es Händlern, qualitativ hochwertige Verbrauchsmaterialien von Katun Performance (Toner, Drucker-/Faxkartuschen, Tinten für Digitalkopierer und Thermotransferrollen) mit ihrem Firmennamen und/oder Logo sowie mit Kontaktinformationen zu versehen. So wissen Verbraucher immer, bei wem sie Produkte nachbestellen können. Für eine einmalige, geringe Bearbeitungsgebühr entwirft und produziert Katun Performance vollfarbige Etiketten nach Ihren eigenen Angaben. Diese werden kostenfrei auf die entsprechenden Verpackungen aufgebracht. Unter dieses Programm fallen nur Produkte, die vom Endverbraucher nachbestellt werden können. Die Teilnahme an dem Programm ist ganz einfach. Füllen Sie einfach die Vereinbarung aus und senden Sie diese an Ihren Katun- Ansprechpartner oder besuchen Sie uns auf unserer Homepage unter Firmenetiketten-Programm für weitere Information zu diesem Programm und den Teilnahmebedingungen.



# Personalized Product Agreement

## Customer Information

Customer Number: \_\_\_\_\_ Phone Number: \_\_\_\_\_  
 Contact Name: \_\_\_\_\_ Fax Number: \_\_\_\_\_  
 Title: \_\_\_\_\_ Katun Representative: \_\_\_\_\_

### Customer agrees to:

- Provide pertinent information, a scanable copy of your company logo, or other desired label artwork, and color specifications for the labels.
- Pay a one-time, nominal setup fee upon approval of the label design. (Ask your sales representative for details.)
- Order in full master carton quantities.

### Katun agrees to:

- Create a personalized, full-color label design to your specifications, per the information provided on page two of this form, for a one-time, nominal setup fee and send a proof for approval within a minimum of 7 days of receipt of this agreement.
- Produce labels printed with the customer's approved design on white label stock, and affix them over the Katun Performance logo\* on copier toner, printer/fax toner cartridge, digital duplicator ink/master packaging.
- Ship initial order within one week after the customer approves their Personalized Product label proof. Reorders will also ship within one week.

## Projected Personalized Product Purchases

<i>Katun Part Number**</i>	<i>OEM Line</i>	<i>Product/Model Description</i>	<i>Minimum Order Quantity</i>	<i>Projected Monthly Order***</i>
P			<i>One master carton</i>	
P			<i>One master carton</i>	
P			<i>One master carton</i>	
P			<i>One master carton</i>	
P			<i>One master carton</i>	
P			<i>One master carton</i>	

**Signature:** \_\_\_\_\_ **Date:** \_\_\_\_\_

\*Only Katun Performance products can be personalized.

\*\*The Personalized Product part number is the regular Katun Performance part number with a 'P' added at the end. See the Katun catalog for master carton quantities.

\*\*\***Projection only.** You are not committed to ordering the quantity you list on this form.

NOTE: Products with personalized labels cannot be returned to Katun for credit unless a valid warranty claim exists.

**Please Also Complete Page 2**



## Central/Eastern Europe

Telephone: 31(0)183-696969

Fax: 31(0)183-629055

E-mail: [order@edc.katun.com](mailto:order@edc.katun.com)

### Information for Personalized Product Label

Please list *only* the information you want to appear on your Personalized Product label.

**Company Name:** \_\_\_\_\_

**Street Address:** \_\_\_\_\_

**City:** \_\_\_\_\_

**State/Province:** \_\_\_\_\_ **Postal Code:** \_\_\_\_\_

**Phone Number:** \_\_\_\_\_ **Fax Number:** \_\_\_\_\_

**Other:** \_\_\_\_\_

### Label Artwork

- **Attach a copy of your company logo and/or any other requested graphic elements.** Artwork may be full color or black and white. We prefer original-quality artwork 4" x 4" (100mm x 100mm) or larger, but will accept a business card or sheet of company letterhead.
- **Please indicate your color preferences.** In the space below, please indicate the color(s) you want to use for all text, your company logo, and any other graphic elements. If appropriate, please supply accurate samples to be matched or specify Pantone or PMS color numbers. **NOTE:** Your labels will be printed on a thermal-transfer printer at a resolution of 300 dpi. Therefore color photographs cannot be printed and some colors may be difficult to match precisely.

### Label Sizes

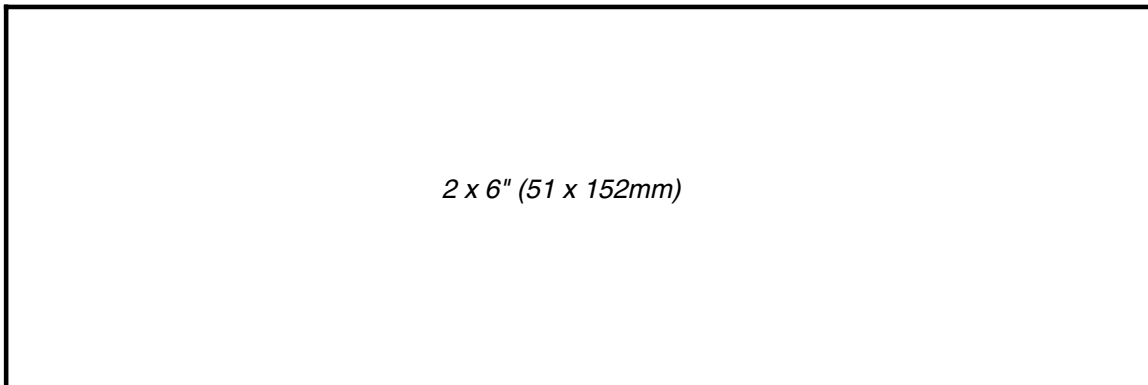
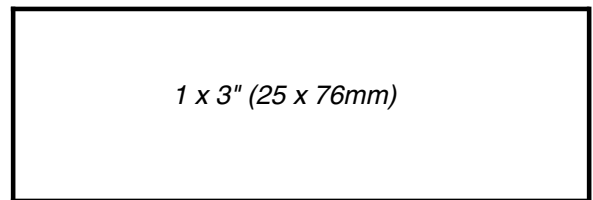
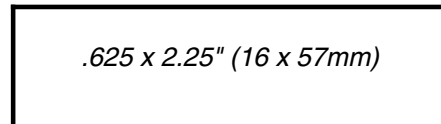
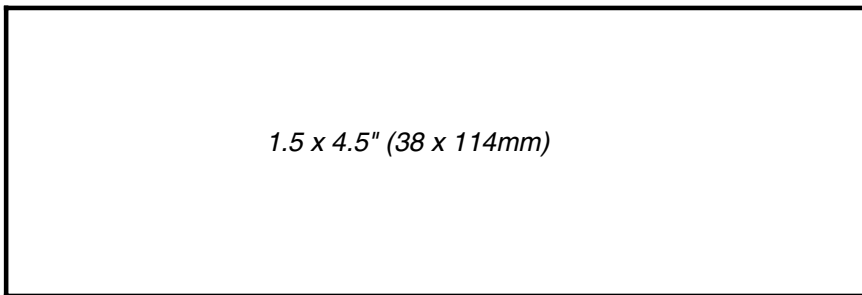

## Vereinbarung über Bestellung von Produkten mit Ihrem Firmenetikett

### Kundeninformationen

Kundennummer: \_\_\_\_\_ Telefon: \_\_\_\_\_  
 Ansprechpartner: \_\_\_\_\_ Fax: \_\_\_\_\_  
 Position: \_\_\_\_\_ Ihr Katun-Repräsentant: \_\_\_\_\_

### Der Kunde ist einverstanden:

- Katun die benötigten Informationen vorzulegen (ein zum Scannen geeignetes Muster Ihres Firmenlogos bzw. Muster anderer gewünschter Grafikelemente sowie Farbspezifikationen für die Etiketten);
- nach Genehmigung des Etiketten-Layouts eine einmalige, geringe Bearbeitungsgebühr zu entrichten. Weitere Informationen erhalten Sie von Ihrem Katun-Repräsentanten;
- Toner in den jeweiligen Verpackungseinheiten/Umkartons zu bestellen.

### Katun verpflichtet sich:

- ein Vollfarbetikett nach den Kundenangaben zu entwerfen (siehe Seite 2 dieses Formulars). Hierfür wird eine einmalige, geringe Bearbeitungsgebühr erhoben. Nach Eingang dieser Vereinbarung bei Katun erhält der Kunde innerhalb von ca. sieben Werktagen einen Korrekturabzug.
- Etiketten in Standardgröße mit dem vom Kunden genehmigten Layout auf weißem Etikettenpapier zu drucken und über dem Katun Performance-Logo\* auf der Verpackung von Toner für Kopierer, Tonerkartuschen für Drucker/Faxgeräte, Tinte bzw. deren Umkartons für digitale Duplikatoren anzubringen.
- den Toner-Erstauftrag innerhalb von einer Woche nach Genehmigung des firmeneigenen Etiketts zu versenden. Nachbestellungen werden ebenfalls innerhalb einer Woche erledigt.

### Erwartete Abnahmemenge von Produkten mit Ihrem Firmenetikett

Katun Artikelnummer**	Maschinenlinie	Produkt-/Modellbeschreibung	Mindestmenge	Erwartete monatliche Bestellung***
P			Ein Umkarton	
P			Ein Umkarton	
P			Ein Umkarton	
P			Ein Umkarton	
P			Ein Umkarton	
P			Ein Umkarton	

Unterschrift: \_\_\_\_\_ Datum: \_\_\_\_\_

\*Nur Katun Performance Produkte können mit Firmenetiketten bestellt werden.

\*\*Die Artikelnummer für Produkte mit Ihrem Firmenetikett ist die normale Katun Performance Artikelnummer, der ein "P" am Ende nachgestellt ist. Sehen Sie die Umkartonmengen im Katun-Katalog nach.

\*\*\***Nur Schätzungen.** Sie sind nicht verpflichtet, die hier angegebene Menge abzunehmen.

HINWEIS: Produkte mit Firmenetiketten können nur bei einer berechtigten Reklamation gutgeschrieben werden.

**Füllen Sie bitte auch Seite 2 aus.**



Katun Performance Product

© 2004 Katun Corporation

## Bestellinformationen für firmeneigenes Etikett

Geben Sie bitte *nur* die Informationen an, die auf dem Etikett erscheinen sollen.

Name der Firma: \_\_\_\_\_

Strasse: \_\_\_\_\_

PLZ/Ort: \_\_\_\_\_

Telefon: \_\_\_\_\_ Fax: \_\_\_\_\_

Sonstiges: \_\_\_\_\_

## Layout des Etiketts

- **Bitte legen Sie kein Muster Ihres Firmenlogos sowie ggf. Muster anderer gewünschter Grafikelemente bei.** Geeignet sind Grafiken in Farbe oder Schwarzweiß, vorzugsweise Originale mit einer Mindestgröße von 100 x 100 mm. Wir können auch Ihre Visitenkarte oder Ihren Briefkopf verarbeiten.
- **Bitte geben Sie die gewünschten Farben an.** Tragen Sie unten bitte die Farbe(n) für alle Textelemente, Ihr Firmenlogo sowie andere grafische Elemente ein. Legen Sie ggf. ein Farbmuster bei, oder geben Sie die Pantone- bzw. PMS-Farbnummern an.  
**HINWEIS:** Ihre Firmenetiketten werden auf einem Thermodrucker mit einer Auflösung von 300 DPI erstellt. Es können daher keine Farbfotos gedruckt werden, und bestimmte Farben können u. U. nicht exakt wiedergegeben werden.



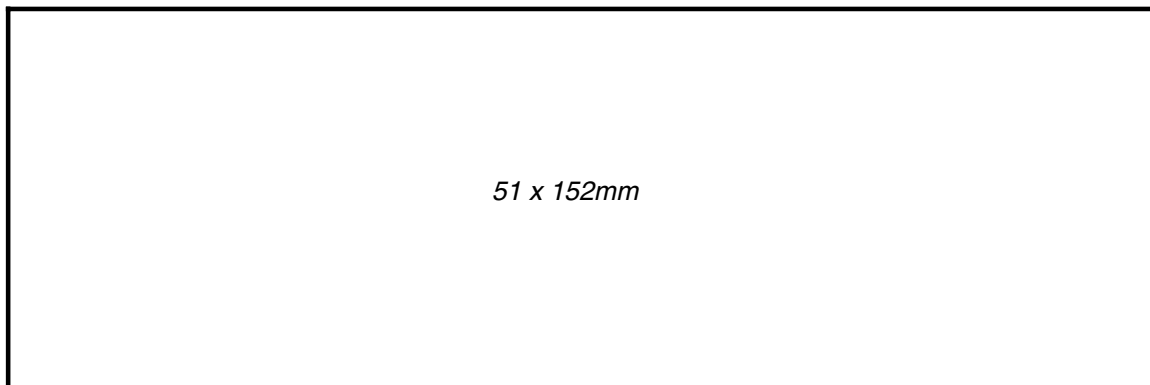
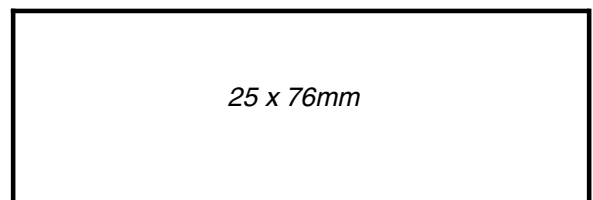
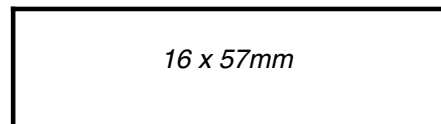
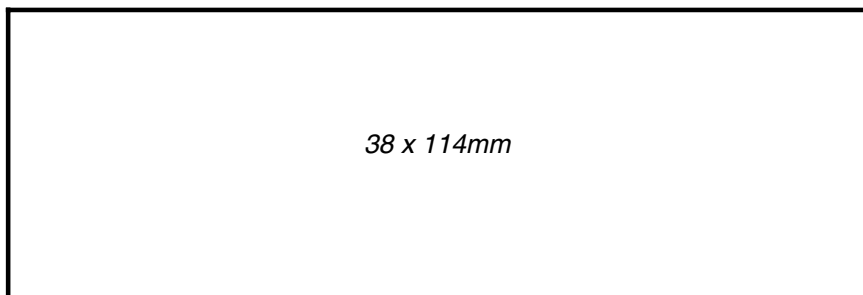

## Etikettengrößen





For use in  
**Canon**  
 Copiers

**Central/Eastern Europe**  
 Telephone: 31(0)183-696969  
 Fax: 31(0)183-629055  
 E-mail: order@edc.katun.com





OEM PN	KATUN PN	DESCRIPTION	MODEL NO.
<b>Bearings/Bushings</b>			
XG9-0013-000	15576204 	<b>Bearing</b> Various Applications Various Applications	SORTER- E2 BJ A1, CLC 1, CLC 200, CLC 300, CLC 320, CLC 350, CLC 500, CLC 550, CLC 700, CLC 700 E, CLC 700 L, CLC 700 S, CLC 800, CLC 800 S, CLC 900, CLC 920, CLC 950, CLC 1000, CLC 1000 S, CLC 3100, CLC 4000, CLC 5000, CLC 5100, iR 5000, iR 5000 i, iR 5020 i, IR 5020 IN, iR 6000, iR 6000 i, IR 6020 I, NP 125, NP 126, NP 150, NP 155, NP 155 DF, NP 200, NP 270, NP 271, NP 275, NP 300, NP 305, NP 400, NP 402, NP 500, NP 505, NP 3025, NP 3030, NP 3050, NP 3225, NP 3325, NP 3525, NP 3725, NP 3825, NP 3825 II, NP 4040, NP 4335, NP 4540, NP 4835, NP 4835 i, NP 5020, NP 5060, NP 6085, NP 6150, NP 6285, NP 6650, NP 6825 DADF, NP 6826 DADF, NP 6831, NP 6835 RDF, NP 6850, NP 6880, NP 6885, NP 7050, NP 7550, NP 8070, NP 8530, NP 8570, NP 8580, NP 9030, NP 9085, NP 9330, NP 9800, NP COLOR, CFU- E1, CFU- F1, DU- A1, PD- 3, PD- 4, PD- 5, PD- 6, SORTER- V, SORTER- B1, SORTER- C1, SORTER- E1, SORTER- IV, SORTER- VII, SORTER- VII -B, STAPLER SORTER, STAPLER SORTER- A1, STAPLER SORTER- B1, STAPLER SORTER- C1, STAPLER SORTER- G1
XG1-1026-085	15576107 	<b>Bearing</b>	BJ A1 S
XG9-0249-000	15576204 	<b>Bearing</b> Various Applications	BJ A1 S, CLC 700, CLC 700 E, CLC 700 L, CLC 700 S, CLC 800, CLC 800 S, CLC 900, CLC 920, CLC 950, CLC 1000, CLC 1000 S, CLC 1100, CLC 1130, CLC 1150, CLC 3100, CLC 4000, CLC 5000, CLC 5100, GP 30 F, GP 55, GP 55 F, GP 55 II, GP 555, GP 605, iR 85, iR 105, iR 3250, iR 7200, iR 8500, IR C 2100, iR C 2100 S, iR C 2105, NP A2 SV, NP A2 SV II, NP 6016, NP 6025, NP 6030, NP 6060, NP 6062, NP 6085, NP 6218, NP 6285, NP 6330, NP 6521, NP 6621, NP 9085















OEM PN	KATUN PN	DESCRIPTION	MODEL NO.	
<b>Bearings/Bushings</b>				
XG9-0208-000	15576204 	<b>Bearing</b> Various Applications  Various Applications  Lower Fuser Roller	BJ A1 S, GP 335, GP 405, GP 555, GP 605, IMAGERUNNER C 6800, iR 85, iR 105, iR 400, iR 2200, iR 2200 i, iR 2800, IR 2800 I, iR 3300, iR 3300 i, iR 7200, iR 8500, iR C 3200, IR C 3200 N, IR C 3200 S, IR C 6800, IR C 6800 N, S 3200 CLC 700, CLC 700 E, CLC 700 L, CLC 700 S, CLC 800, CLC 800 S, CLC 900, CLC 920, CLC 950, CLC 1100, CLC 1130, CLC 1150, GP 30 F, NP 4335, NP 4835, NP 4835 i, NP 6045, NP 6050, NP 6050 ER, NP 6060, NP 6062, NP 6085, NP 6251, NP 6260, NP 6285, NP 6350, NP 6360, NP 6835 RDF, NP 7500, NP 9085, PDP- K1 GP 55, GP 55 F, GP 55 II, NP 4050, NP 4080, NP 6025, NP 6028, NP 6030, NP 6035, NP 6035 F, NP 6241, NP 6330	
XG9-0094-000	15576233 	<b>Bearing</b> Various Applications  Lower Fuser Roller	CLC 1, CLC 200, CLC 300, CLC 320, CLC 350, CLC 500, CLC 550, CLC 700, CLC 700 E, CLC 700 L, CLC 700 S, CLC 800, CLC 800 S, CLC 900, CLC 920, CLC 950, CLC 1000, CLC 1000 S, CLC 3100, CLC 4000, CLC 5000, CLC 5100, GP 335, GP 405, iR 400, NP 3030, NP 3050, NP 3325, NP 3825, NP 3825 II, NP 4040, NP 4335, NP 4540, NP 4835, NP 4835 i, NP 5020, NP 5060, NP 6150, NP 6650, NP 6825 DADF, NP 6826 DADF, NP 6831, NP 6835 RDF, NP 6850, NP 6880, NP 6885, NP 7550, NP 8070, NP 8530, NP 8570, NP 8580, NP 9030, NP 9330, NP 9800, ADF- A1, AF- 1, BufferPass Unit 1, BUFFERPASS UNIT D1, CFU- F1, D- ADF, DF- 3, DU- A1, RDF- 1, RDF- 2, RDF- 2 N, RDF- 3, RF- 2, RF- 3, SORTER- B1, STAPLER SORTER- A1, STAPLER SORTER- B1 NP 150, NP 155, NP 155 DF, NP 200, NP 270, NP 271, NP 275, NP 305, NP 2015, NP 2015 F, NP 2017, NP 2215, NP 3025, NP 3225, NP 3525, NP 3725, NP COLOR	
FA3-0652-000	15017250 	<b>Heat Insulating Sleeve</b> Various Applications  Rear	CLC 1, CLC 200, CLC 300, CLC 320, CLC 350, CLC 500, CLC 550, CLC 700, CLC 700 E, CLC 700 L, CLC 700 S, CLC 800, CLC 800 S, CLC 900, CLC 920, CLC 950, CLC 1000, CLC 1000 S, CLC 3100, CLC 4000, CLC 5000, CLC 5100, iR C 3200, IR C 3200 N, IR C 3200 S, S 3200 NP 9030, NP 9330	<i>Priced per Heat Sleeve, sold in Bags of 10.</i>

For use in  
**Canon**  
Copiers

**Central/Eastern Europe**  
Telephone: 31(0)183-696969  
Fax: 31(0)183-629055  
E-mail: order@edc.katun.com

OEM PN	KATUN PN	DESCRIPTION	MODEL NO.
<b>Bearings/Bushings</b>			
XG2-8016-505	15576118 	<b>Bearing</b> Various Applications	CLC 1, CLC 200, CLC 300, CLC 320, CLC 350, CLC 500, CLC 550, NP 150, NP 155, NP 155 DF, NP 200, NP 210, NP 270, NP 271, NP 275, NP 300, NP 305, NP 400, NP 402, NP 500, NP 505, NP 3025, NP 3225, NP 3525, NP 3725, NP 4040, NP 4540, NP 5020, NP 5060, NP 6045, NP 6050, NP 6050 ER, NP 6150, NP 6251, NP 6260, NP 6350, NP 6360, NP 6650, NP 6850, NP 6880, NP 6885, NP 7050, NP 7500, NP 7550, NP 8070, NP 8530, NP 8570, NP 8580, NP 9030, NP 9800, NP COLOR, AF- 1, DF- 3
FS1-1335-000	15576209 	<b>Fuser Roller Bearing</b> Upper, Lower  Lower	CLC 200, CLC 300, CLC 320, CLC 350, CLC 500, CLC 550, CLC 700, CLC 700 E, CLC 700 L, CLC 700 S, CLC 800, CLC 800 S, CLC 900, CLC 920, CLC 950, CLC 1000, CLC 1000 S, CLC 3100, CLC 4000, CLC 5000, CLC 5100 NP 6880, NP 6885, NP 7050, NP 7550, NP 8070, NP 8530, NP 8570, NP 8580, NP 9800
XG9-0250-000	15576233 	<b>Bearing</b> Various Applications	CLC 700, CLC 700 E, CLC 700 L, CLC 700 S, CLC 800, CLC 800 S, CLC 900, CLC 920, CLC 950, CLC 1000, CLC 1000 S, CLC 1100, CLC 1130, CLC 1150, CLC 3100, CLC 4000, CLC 5000, CLC 5100, GP 210, GP 215, GP 220, GP 225, GP 335, GP 405, GP 555, GP 605, IMAGERUNNER C 6800, iR 85, iR 105, iR 400, iR 2200, iR 2200 i, iR 2800, IR 2800 I, iR 3300, iR 3300 i, iR 5000, iR 5000 i, iR 5020 i, IR 5020 IN, iR 6000, iR 6000 i, IR 6020 I, iR 7200, iR 8500, IR C 2100, iR C 2100 S, iR C 2105, IR C 6800, NP 6035, NP 6035 F, NP 6045, NP 6050, NP 6050 ER, NP 6060, NP 6062, NP 6085, NP 6241, NP 6251, NP 6260, NP 6285, NP 6330, NP 6350, NP 6360, NP 7160, NP 7161, NP 7164, NP 7500, NP 9085, PD- A1, PD- B1, PD- C1, PD- H1, PD- L1, PD- M1, PD- P1, PD- R1, PDP- D1, PDP- K1
XG9-0172-000	15576118 	<b>Bearing</b> Various Applications  Lower Fuser Roller	CLC 700, CLC 700 E, CLC 700 L, CLC 700 S, CLC 800, CLC 800 S, CLC 900, CLC 920, CLC 950, IR C 2100, iR C 2100 S, iR C 2105, NP 2020, NP 2120, NP 3020, NP 6016, NP 6218, NP 6221, NP 6317, NP 6318, NP 6320, NP 6521, NP 6621 NP 1015, NP 1215, NP 1318, NP 1510, NP 1520, NP 1530, NP 1550, NP 2010, NP 2017, NP 6020, NP 6116, NP 6216, NP 6220



OEM PN	KATUN PN	DESCRIPTION	MODEL NO.
<b>Bearings/Bushings</b>			
XG9-0237-000	15576233 	<b>Bearing</b> Various Applications  Various Applications	GP 160, GP 160 F, iR 5000, iR 5000 i, iR 5020 i, IR 5020 IN, iR 6000, iR 6000 i, IR 6020 I CLC 700, CLC 700 E, CLC 700 L, CLC 700 S, CLC 800, CLC 800 S, GP 555, GP 605, NP 4080, NP 6050, NP 6050 ER, NP 6212, NP 6251, NP 6260, NP 6312, NP 6350, NP 6360, NP 6512, NP 6612, NP 6885, NP 7130, NP 7130 F, NP 7500, NP 8530, NP 9800, ADF- C1, ADF- D1, ADF- E1, DADF- A1, PDP- K1, RDF- A1, RDF- B1, RDF- C1, RDF- F1, RDF- G1, RDF- H1, STAPLER SORTER- J1
XG9-0399-000	15576209 	<b>Upper/Lower Fuser Roller Bearing</b>	CLC 1100, CLC 1130, CLC 1150
XG9-0379-000	15576205 	<b>Bearing</b>	CLC 1100, CLC 1130, CLC 1150, iR 3250
FB1-6823-000	15013600 	<b>Upper Heat Insulating Sleeve</b>	GP 30 F, GP 55, GP 55 F, GP 55 II, GP 335, GP 405, iR 400, iR 3250, NP 6025, NP 6028, NP 6030, NP 6035, NP 6035 F, NP 6330
FB1-6823-000	15013870	<b>Upper Heat Insulating Sleeve Original</b>	GP 30 F, GP 55, GP 55 F, GP 55 II, GP 335, GP 405, iR 400, iR 3250, NP 6025, NP 6028, NP 6030, NP 6035, NP 6035 F, NP 6330
XG9-0266-000	15576216 	<b>Upper Fuser Roller Bearing</b>	GP 30 F, GP 55, GP 55 F, GP 55 II, NP 6025, NP 6028, NP 6030, NP 6035, NP 6035 F, NP 6330
N/P/N	15015694 	<b>Upper Fuser Roller Bearing Kit</b> Kit Contains: • (2) Upper Heat Insulating Sleeve • (2) Upper Fuser Roller Bearing	GP 30 F, GP 55, GP 55 F, GP 55 II, NP 6025, NP 6028, NP 6030, NP 6035, NP 6035 F, NP 6330
XG9-0356-000	15576216 	<b>Upper Fuser Roller Bearing</b>	GP 335, GP 405, iR 400
XG9-0248-000	15576203 	<b>Bearing</b> Various Applications Various Applications	GP 555, GP 605, iR 85, iR 105, iR 7200, iR 8500 NP 6060, NP 6062, NP 6085, NP 6285, NP 9085
XG9-0018-000	15021524 	<b>Bearing</b> Various Applications Lower Fuser Roller	iR 85, iR 8500 GP 555, GP 605, iR 105, NP 4040, NP 4540, NP 5020, NP 5060, NP 6150, NP 6650, NP 6850
XG9-0383-000	15021524 	<b>Bearing</b>	GP 555, GP 605, iR 5000, iR 5000 i, iR 5020 i, IR 5020 IN, iR 6000, iR 6000 i, IR 6020 I, NP 6260, NP 6360
FB2-7239-000	15013600 	<b>Heat Insulating Sleeve</b>	GP 555, GP 605, NP 6045, NP 6050, NP 6050 ER, NP 6251, NP 6350, NP 7500
XG9-0325-000	15015322 	<b>Upper Fuser Roller Bearing</b>	GP 555, GP 605, NP 6045, NP 6050, NP 6050 ER, NP 6251, NP 6350, NP 7500















*Priced per Heat Sleeve, sold in Bags of 10.*

*Priced per Heat Sleeve, sold in Bags of 10.*











*Priced per Heat Sleeve, sold in Bags of 10.*

For use in  
**Canon**  
 Copiers

**Central/Eastern Europe**  
 Telephone: 31(0)183-696969  
 Fax: 31(0)183-629055  
 E-mail: order@edc.katun.com

OEM PN	KATUN PN	DESCRIPTION	MODEL NO.
<b>Bearings/Bushings</b>			
FS2-1617-000	15576118 	<b>Bearing</b> Various Applications Various Applications	GP 555, GP 605, FINISHER- D1 RDF- D1, RDF- E1, RDF- E3
XG9-0421-000	15015322 	<b>Upper Fuser Roller Bearing</b>	IMAGERUNNER C 6800, iR 85, iR 105, iR 5000, iR 5000 i, iR 5020 i, IR 5020 IN, iR 6000, iR 6000 i, IR 6020 I, iR 7200, iR 8500, IR C 6800, IR C 6800 N
XG9-0324-000	15016005 	<b>Bearing</b>	IMAGERUNNER C 6800, iR 5000, iR 5000 i, iR 5020 i, IR 5020 IN, iR 6000, iR 6000 i, IR 6020 I, IR C 6800, IR C 6800 N, NP 6045, NP 6050, NP 6050 ER, NP 6251, NP 6260, NP 6350, NP 6360, NP 7500
RB1-0325-000	15009451 	<b>Heat Insulating Sleeve</b>	IMAGERUNNER C 6800, IR C 6800, IR C 6800 N
			<i>Priced per Heat Sleeve, sold in Bags of 10.</i>
XG9-0377-000	15576217 	<b>Upper Fuser Roller Bearing</b>	iR 3250
XG9-0304-000	15576205 	<b>Bearing</b>	iR 3250, NP 6085, NP 6285, NP 9085
XG9-0422-000	15576217 	<b>Bearing</b>	IR C 2100, iR C 2100 S, iR C 2105
XG9-0415-000	15576118 	<b>Bearing</b>	IR C 2100, iR C 2100 S, iR C 2105, iR C 3200, IR C 3200 N, IR C 3200 S, S 3200
XG9-0182-000	15576204 	<b>Lower Fuser Roller Bearing</b>	IR C 2100, iR C 2100 S, iR C 2105, NP 4335, NP 4835, NP 4835 i, NP 6835 RDF
XG2-8022-705	15576205 	<b>Bearing</b> Various Applications	NP A1, NP 120, NP 125, NP 126, NP 500, NP 505, NP 6085, NP 6285, NP 6880, NP 6885, NP 7050, NP 7550, NP 8070, NP 8530, NP 8570, NP 8580, NP 9085, NP 9800, NP COLOR, FINISHER- B1, PD- 2, PD- 3, PD- 4, PD- 5
FE5-7024-000	15576217 	<b>Upper Fuser Roller Bearing</b>	NP A2 SV, NP A2 SV II
FS1-1240-000	15576207 	<b>Upper Fuser Roller Bushing</b>	NP 150, NP 155, NP 155 DF, NP 270, NP 271, NP 275, NP 305, NP 1015, NP 1215, NP 1318, NP 1510, NP 1520, NP 1530, NP 1550, NP 2010, NP 6116, NP 6216, NP 6317, NP 6318, NP 6320
XG9-0103-000	15576209 	<b>Upper Fuser Roller Bearing</b>	NP 300, NP 9030, NP 9330
FS1-1151-000	15576203 	<b>Lower Fuser Roller Bearing</b>	NP 400, NP 402, NP 500, NP 505
FS1-1152-000	15576225 	<b>Upper Fuser Roller Bearing</b>	NP 400, NP 402, NP 500, NP 505









OEM PN	KATUN PN	DESCRIPTION	MODEL NO.	
<b>Bearings/Bushings</b>				
N/P/N	15015697 	<b>Upper Fuser Roller Bearing Kit</b> Kit Contains: • (2) Heat Insulating Sleeve • (2) Upper Fuser Roller Bearing	NP 2020, NP 2120, NP 3020, NP 3030, NP 3050, NP 3325, NP 3825, NP 3825 II, NP 4050, NP 4080, NP 4335, NP 4835, NP 4835 i, NP 6220, NP 6221, NP 6241, NP 6825 DADF, NP 6826 DADF, NP 6831, NP 6835 RDF	
XG9-0181-000	15021526 	<b>Upper Fuser Roller Bearing</b>	NP 2020, NP 2120, NP 3020, NP 3030, NP 3050, NP 3325, NP 3825, NP 3825 II, NP 4050, NP 4080, NP 4335, NP 4835, NP 4835 i, NP 6221, NP 6241, NP 6825 DADF, NP 6826 DADF, NP 6831, NP 6835 RDF	
XG9-0200-000	15021531 	<b>Lower Fuser Roller Bearing</b>	NP 2020, NP 2120, NP 3020, NP 3030, NP 3050, NP 3325, NP 3825, NP 3825 II, NP 6221, NP 6825 DADF, NP 6826 DADF, NP 6831	
FA5-2967-000	15013942 	<b>Heat Insulating Sleeve</b>	NP 2020, NP 2120, NP 3020, NP 3325, NP 3825, NP 3825 II, NP 4335, NP 4835, NP 4835 i, NP 6020, NP 6220, NP 6221, NP 6825 DADF, NP 6826 DADF, NP 6835 RDF	<i>Priced per Heat Sleeve, sold in Bags of 10.</i>
XG9-0139-000	15576216 	<b>Upper Fuser Roller Bearing</b>	NP 3025, NP 3225, NP 3525, NP 3725, NP 4040, NP 4540, NP 5020, NP 5060, NP 6150, NP 6650, NP 6850	
FA3-2668-020	15013941 	<b>Heat Insulating Sleeve</b> Various Applications  Rear	NP 3025, NP 3225, NP 3525, NP 3725, NP 6880, NP 6885, NP 7050, NP 7550, NP 8070, NP 8530, NP 8570, NP 8580, NP 9800 NP 4040, NP 4540, NP 5020, NP 5060, NP 6150, NP 6650, NP 6850	<i>Priced per Heat Sleeve, sold in Bags of 10.</i>
FB1-5928-000	15013942 	<b>Heat Insulating Sleeve</b>	NP 3030, NP 3050, NP 4050, NP 4080, NP 6241, NP 6831	<i>Priced per Heat Sleeve, sold in Bags of 10.</i>
FA4-0627-000	15013940 	<b>Heat Insulating Sleeve</b> Front	NP 4040, NP 4540, NP 5020, NP 5060, NP 6150, NP 6650, NP 6850	<i>Priced per Heat Sleeve, sold in Bags of 10.</i>
N/P/N	15015696 	<b>Upper Fuser Roller Bearing Kit</b> Kit Contains: • (1) Heat Insulating Sleeve • (1) Heat Insulating Sleeve • (2) Upper Fuser Roller Bearing	NP 4040, NP 4540, NP 5020, NP 5060, NP 6150, NP 6650, NP 6850	
N/P/N	15015693 	<b>Upper Fuser Roller Bearing Kit</b> Kit Contains: • (2) Upper Heat Insulating Sleeve • (2) Upper Fuser Roller Bearing	NP 6045, NP 6050, NP 6050 ER, NP 6251, NP 6350, NP 7500	
XG9-0261-000	15021524 	<b>Lower Fuser Roller Bearing</b>	NP 6060, NP 6062	

For use in  
**Canon**  
 Copiers







**Central/Eastern Europe**  
 Telephone: 31(0)183-696969  
 Fax: 31(0)183-629055  
 E-mail: order@edc.katun.com

OEM PN	KATUN PN	DESCRIPTION	MODEL NO.
--------	----------	-------------	-----------

### Bearings/Bushings















XG9-0247-000	15576216 	<b>Upper Fuser Roller Bearing</b>	NP 6060, NP 6062, NP 6085, NP 6285, NP 9085
XG9-0300-000	15021530 	<b>Lower Fuser Roller Bearing</b>	NP 6085, NP 6285, NP 9085
XG9-0382-000	15015322 	<b>Upper Fuser Roller Bearing</b>	NP 6260, NP 6360
FS1-1334-020	15576217 	<b>Upper Fuser Roller Bearing</b>	NP 6880, NP 6885, NP 7050, NP 7550, NP 8070, NP 8530, NP 8570, NP 8580, NP 9800
FS2-1615-000	15576233 	<b>Bearing</b> Various Applications	FINISHER- B1, RDF- D1, RDF- E1, RDF- E3
XG9-0365-000	15576233 	<b>Bearing</b> Various Applications	FINISHER- D1



OEM PN	KATUN PN	DESCRIPTION	MODEL NO.
<b>Belts</b>			
FC2-1210-000	15014560 	<b>Original Document Feed Belt</b> Made in Japan	GP 555, GP 605, RDF- D1, RDF- E1, RDF- E2, RDF- E3
FA5-1891-020	15012387 	<b>Transport Belt</b>	NP 1015, NP 1215, NP 1318, NP 1510, NP 1530, NP 1550, NP 2010, NP 2020, NP 2120, NP 6221, NP 6318
FA6-5331-000	15012387 	<b>Transport Belt</b>	NP 2020, NP 2120, NP 6221
FA3-4683-000	15018127 	<b>Original Document Feed Belt</b>	ADF- A1, AF- 1, D- ADF, DF- 1, DF- 2, DF- 3, DF- 4, DF- 5, RDF- 1, RDF- 2, RDF- 2 N, RDF- 3, RDF- A1
FC1-7815-020	15010209 	<b>Original Document Feed Belt</b> Enhanced Urethane Coating	ADF- C1, ADF- D1, ADF- E1, DADF- A1, DADF- G1, RDF- B1, RDF- C1, RDF- F1, RDF- G1, RDF- H1
FC1-7815-020	15017608 	<b>Original Document Feed Belt</b>	ADF- C1, ADF- D1, ADF- E1, DADF- A1, DADF- G1, RDF- B1, RDF- C1, RDF- F1, RDF- G1, RDF- H1
FY1-0940-000	15018127 	<b>Original Document Feed Belt</b>	RDF- A1
			<i>Priced per Package, 4 Belts per Package.</i>
			<i>Priced per Package, 4 Belts per Package.</i>





For use in  
**Canon**  
 Copiers

**Central/Eastern Europe**  
 Telephone: 31(0)183-696969  
 Fax: 31(0)183-629055  
 E-mail: order@edc.katun.com

OEM PN	KATUN PN	DESCRIPTION	MODEL NO.
<b>Blades/Brushes</b>			
FB2-6305-040	15022560 	<b>Fuser Oil Metering Blade</b>	CLC 700, CLC 700 E, CLC 700 L, CLC 700 S, CLC 800, CLC 800 S, CLC 900, CLC 920, CLC 950
FB3-2047-000	15016928 	<b>Lower Fuser Roller Cleaning Blade</b>	CLC 700, CLC 700 E, CLC 700 L, CLC 700 S, CLC 800, CLC 800 S, CLC 900, CLC 920, CLC 950, CLC 1000, CLC 1000 S, CLC 3100, CLC 3900, CLC 4000, CLC 5000, CLC 5100
FB2-2887-000	15019169 	<b>Drum/Transfer Belt Cleaning Blade</b>	CLC 1000, CLC 1000 S, CLC 3100
FB3-9466-000	15022560 	<b>Fuser Oil Blade</b>	CLC 1000, CLC 1000 S, CLC 3100, CLC 3900, CLC 5000
FB4-4536-000	15022561 	<b>Fuser Oil Blade</b>	CLC 1100, CLC 1130, CLC 1150
FB4-4677-000	15021491 	<b>Drum Cleaning Blade</b>	CLC 1100, CLC 1130, CLC 1150
FB4-4953-000	15021901 	<b>Transfer Drum Cleaning Brush</b>	CLC 1100, CLC 1130, CLC 1150
FB4-1596-000	15019621 	<b>Drum Cleaning Blade</b>	GP 555, GP 605
FF5-7934-000	15019863 	<b>Pretransfer Scraper Blade</b>	GP 555, GP 605
FB6-2720-000	15019621 	<b>Drum Cleaning Blade</b>	iR 85, iR 105, iR 7200, iR 8500
FB2-8453-000	15019621 	<b>Drum Cleaning Blade</b>	iR 5000, iR 5000 i, iR 5020 i, IR 5020 IN, iR 6000, iR 6000 i, IR 6020 I, NP 6045, NP 6251, NP 6260, NP 6360, NP 7500
FA4-1827-000	15010697 	<b>Drum Cleaning Blade</b>	iR 5000, iR 5000 i, iR 6000, NP 5020, NP 5060, NP 6050, NP 6050 ER, NP 6060, NP 6062, NP 6150, NP 6251, NP 6650, NP 6850, NP 6880, NP 6885, NP 7050, NP 7500, NP 7550, NP 8070, NP 8530, NP 8570, NP 8580, NP 9800
FA4-1827-000	15243442 	<b>Drum Cleaning Blade</b>	iR 5000, iR 5000 i, iR 6000, NP 5020, NP 5060, NP 6050, NP 6050 ER, NP 6060, NP 6062, NP 6150, NP 6251, NP 6650, NP 6850, NP 6880, NP 6885, NP 7050, NP 7500, NP 7550, NP 8070, NP 8530, NP 8570, NP 8580, NP 9800
FA4-1827-000	15022572	<b>Drum Cleaning Blade Access By Katun</b>	iR 5000, iR 5000 i, iR 6000, NP 5020, NP 5060, NP 6050, NP 6050 ER, NP 6060, NP 6062, NP 6150, NP 6251, NP 6650, NP 6850, NP 6880, NP 6885, NP 7050, NP 7500, NP 7550, NP 8070, NP 8530, NP 8570, NP 8580, NP 9800
FA9-2733-000	15012044 	<b>Drum Cleaning Blade</b>	NP 1010, NP 1020, NP 6010



*Priced per Kit,  
 10 Blades per Kit.*



OEM PN	KATUN PN	DESCRIPTION	MODEL NO.
<b>Blades/Brushes</b>			
FA5-1672-080	15016097 	<b>Drum Cleaning Blade</b>	NP 1015, NP 1215, NP 1318, NP 1510, NP 1520, NP 1530, NP 1550, NP 2010, NP 2020, NP 2120, NP 3020, NP 6020, NP 6116, NP 6216, NP 6220, NP 6221, NP 6317, NP 6318
FA5-1672-080	15020051	<b>Drum Cleaning Blade Access By Katun</b>	NP 1015, NP 1215, NP 1318, NP 1510, NP 1520, NP 1530, NP 1550, NP 2010, NP 2020, NP 2120, NP 3020, NP 6020, NP 6116, NP 6216, NP 6220, NP 6221, NP 6317, NP 6318
N/P/N	15243430 	<b>Drum Cleaning Blade</b>	NP 3025, NP 3225, NP 3525, NP 3725
FA5-2524-000	15243418 	<b>Drum Cleaning Blade</b>	NP 3030, NP 3050, NP 3325, NP 3825, NP 3825 II, NP 4050, NP 4080, NP 4335, NP 4835, NP 4835 i, NP 6241, NP 6825 DADF, NP 6826 DADF, NP 6831, NP 6835 RDF
FA5-2524-000	15022571	<b>Drum Cleaning Blade Access By Katun</b>	NP 3030, NP 3050, NP 3325, NP 3825, NP 3825 II, NP 4050, NP 4080, NP 4335, NP 4835, NP 4835 i, NP 6241, NP 6825 DADF, NP 6826 DADF, NP 6831, NP 6835 RDF
FB3-8809-000	15243442 	<b>Drum Cleaning Blade</b>	NP 6085, NP 6285, NP 9085
N/P/N	15023250 	<b>Drum Cleaning Blade</b>	NP 7160, NP 7161, NP 7164

For use in  
**Canon**  
Copiers

**Central/Eastern Europe**  
Telephone: 31(0)183-696969  
Fax: 31(0)183-629055  
E-mail: order@edc.katun.com

OEM PN	KATUN PN	DESCRIPTION	MODEL NO.
<b>Corona/Charge/Transfer</b>			
FY3-0040-000	15375120 	<b>Corona Wire Spool</b> 50 m / Spool 60μ 0.3μ Gold Plated All Applications Except Grid	CLC 1, CLC 200, CLC 300, CLC 320, CLC 350, CLC 500, CLC 550, CLC 700, CLC 700 E, CLC 700 L, CLC 700 S, CLC 800, CLC 800 S, CLC 900, CLC 920, CLC 950, CLC 1000, CLC 1000 S, CLC 1100, CLC 1130, CLC 1150, CLC 3100, CLC 3900, CLC 4000, CLC 5000, CLC 5100, GP 30 F, NP 115, NP 120, NP 125, NP 126, NP 150, NP 155, NP 155 DF, NP 200, NP 210, NP 270, NP 271, NP 275, NP 300, NP 305, NP 400, NP 402, NP 500, NP 505, NP 1015, NP 1215, NP 1318, NP 1510, NP 1520, NP 1530, NP 1550, NP 2010, NP 2015, NP 2015 F, NP 2017, NP 2020, NP 2120, NP 2215, NP 3020, NP 3025, NP 3030, NP 3050, NP 3225, NP 3325, NP 3525, NP 3725, NP 3825, NP 3825 II, NP 4040, NP 4050, NP 4080, NP 4335, NP 4540, NP 4835, NP 4835 i, NP 5020, NP 5060, NP 6020, NP 6045, NP 6060, NP 6062, NP 6116, NP 6150, NP 6216, NP 6220, NP 6221, NP 6241, NP 6318, NP 6320, NP 6330, NP 6650, NP 6825 DADF, NP 6826 DADF, NP 6831, NP 6835 RDF, NP 6850, NP 6880, NP 6885, NP 7050, NP 7550, NP 8070, NP 8530, NP 8570, NP 8580, NP 9030, NP 9330, NP 9800
		Pretransfer, Transfer, Separation	IR C 2100, iR C 2100 S, iR C 2105, NP A2 SV, NP A2 SV II, NP 6350, NP 9085
		Transfer	NP 7160, NP 7161, NP 7164
Y81-0162-000	15375121 	<b>Grid Wire Spool</b> 50 m / Spool 100μ 0.3μ Gold Plated	CLC 1, CLC 200, CLC 300, CLC 320, CLC 350, CLC 500, CLC 550, CLC 700, CLC 700 E, CLC 700 L, CLC 700 S, CLC 800, CLC 800 S, CLC 900, CLC 920, CLC 950, NP 115, NP 120, NP 125, NP 126, NP 150, NP 155, NP 155 DF, NP 200, NP 210, NP 270, NP 271, NP 275, NP 300, NP 305, NP 400, NP 402, NP 500, NP 505, NP 1015, NP 1215, NP 1318, NP 1510, NP 1520, NP 2010, NP 2015, NP 2015 F, NP 2017, NP 2215, NP 3025, NP 3030, NP 3050, NP 3225, NP 3325, NP 3525, NP 3725, NP 3825, NP 3825 II, NP 4040, NP 4050, NP 4080, NP 4335, NP 4540, NP 4835, NP 4835 i, NP 5020, NP 5060, NP 6050, NP 6050 ER, NP 6060, NP 6062, NP 6150, NP 6241, NP 6318, NP 6650, NP 6825 DADF, NP 6826 DADF, NP 6831, NP 6835 RDF, NP 6850, NP 6880, NP 6885, NP 7050, NP 7550, NP 8070, NP 8530, NP 8570, NP 8580, NP 9030, NP 9330, NP 9800



OEM PN	KATUN PN	DESCRIPTION	MODEL NO.
-----------	-------------	-------------	--------------

## Corona/Charge/Transfer

FY1-0883-000	15375549 	<b>Corona Wire Spool</b> 50 m / Spool 100µ Stainless Steel Grid	CLC 1, CLC 200, CLC 300, CLC 320, CLC 350, CLC 500, CLC 550, CLC 700, CLC 700 E, CLC 700 L, CLC 700 S, CLC 800, CLC 800 S, GP 555, GP 605, IMAGERUNNER C 6800, iR 85, iR 105, iR 5000, iR 5000 i, iR 5020 i, IR 5020 IN, iR 6000, iR 6000 i, IR 6020 I, iR 7200, iR 8500, IR C 6800, IR C 6800 N, NP A2 SV, NP A2 SV II, NP 115, NP 120, NP 125, NP 126, NP 150, NP 155, NP 155 DF, NP 200, NP 210, NP 270, NP 271, NP 275, NP 300, NP 305, NP 400, NP 402, NP 500, NP 505, NP 1015, NP 1215, NP 1318, NP 1510, NP 1520, NP 2010, NP 2015, NP 2015 F, NP 2017, NP 2215, NP 3020, NP 3025, NP 3030, NP 3050, NP 3225, NP 3325, NP 3525, NP 3725, NP 3825, NP 3825 II, NP 4040, NP 4050, NP 4080, NP 4335, NP 4540, NP 4835, NP 4835 i, NP 5020, NP 5060, NP 6045, NP 6050, NP 6050 ER, NP 6060, NP 6062, NP 6085, NP 6116, NP 6150, NP 6216, NP 6220, NP 6241, NP 6251, NP 6260, NP 6285, NP 6318, NP 6350, NP 6360, NP 6650, NP 6825 DADF, NP 6826 DADF, NP 6831, NP 6835 RDF, NP 6850, NP 6880, NP 6885, NP 7050, NP 7500, NP 7550, NP 8070, NP 8530, NP 8570, NP 8580, NP 9030, NP 9085, NP 9330, NP 9800 Charge, Transfer GP 55, GP 55 F, GP 55 II
--------------	---	---	--







For use in  
**Canon**  
 Copiers

**Central/Eastern Europe**  
 Telephone: 31(0)183-696969  
 Fax: 31(0)183-629055  
 E-mail: order@edc.katun.com

OEM PN	KATUN PN	DESCRIPTION	MODEL NO.
<b>Corona/Charge/Transfer</b>			
N/P/N	15375528 	<b>Grid Wire Spool</b> 50 m / Spool Increased plating thickness enhances corona wire life. 100μ 1.5μ Gold Plated Various Applications	CLC 1, CLC 200, CLC 300, CLC 320, CLC 350, CLC 500, CLC 550, CLC 700, CLC 700 E, CLC 700 L, CLC 700 S, CLC 800, CLC 800 S, GP 555, GP 605, iR 85, iR 105, iR 5000, iR 6000, iR 8500, NP A2 SV, NP A2 SV II, NP 115, NP 120, NP 125, NP 126, NP 150, NP 155, NP 155 DF, NP 200, NP 210, NP 270, NP 271, NP 275, NP 300, NP 305, NP 400, NP 402, NP 500, NP 505, NP 1015, NP 1215, NP 1318, NP 1510, NP 1520, NP 2010, NP 2015, NP 2015 F, NP 2017, NP 2215, NP 3020, NP 3025, NP 3030, NP 3050, NP 3225, NP 3325, NP 3525, NP 3725, NP 3825, NP 3825 II, NP 4040, NP 4050, NP 4080, NP 4335, NP 4540, NP 4835, NP 4835 i, NP 5020, NP 5060, NP 6045, NP 6050, NP 6050 ER, NP 6060, NP 6062, NP 6085, NP 6116, NP 6150, NP 6216, NP 6220, NP 6241, NP 6251, NP 6260, NP 6285, NP 6318, NP 6350, NP 6360, NP 6650, NP 6825 DADF, NP 6826 DADF, NP 6831, NP 6835 RDF, NP 6850, NP 6880, NP 6885, NP 7050, NP 7500, NP 7550, NP 8070, NP 8530, NP 8570, NP 8580, NP 9030, NP 9085, NP 9330, NP 9800 GP 55, GP 55 F, GP 55 II
		Charge, Transfer	



OEM PN	KATUN PN	DESCRIPTION	MODEL NO.
<b>Corona/Charge/Transfer</b>			
FY1-0275-000	15375527 	<b>Corona Wire Spool</b> 50 m / Spool Increased plating thickness enhances corona wire life. 60μ 1.5μ Gold Plated All Applications Except Grid	CLC 1, CLC 200, CLC 300, CLC 350, CLC 500, CLC 550, CLC 700, CLC 700 E, CLC 700 L, CLC 700 S, CLC 800, CLC 800 S, NP A2 SV, NP A2 SV II, NP 115, NP 120, NP 125, NP 126, NP 150, NP 155, NP 155 DF, NP 200, NP 210, NP 270, NP 271, NP 275, NP 300, NP 305, NP 400, NP 402, NP 500, NP 505, NP 1015, NP 1215, NP 1318, NP 1510, NP 1520, NP 1530, NP 1550, NP 2010, NP 2015, NP 2015 F, NP 2017, NP 2020, NP 2120, NP 2215, NP 3025, NP 3030, NP 3050, NP 3225, NP 3325, NP 3525, NP 3725, NP 3825, NP 3825 II, NP 4040, NP 4050, NP 4080, NP 4335, NP 4540, NP 4835, NP 4835 i, NP 5020, NP 5060, NP 6060, NP 6062, NP 6116, NP 6150, NP 6216, NP 6221, NP 6241, NP 6318, NP 6650, NP 6825 DADF, NP 6826 DADF, NP 6831, NP 6835 RDF, NP 6850, NP 6880, NP 6885, NP 7050, NP 7550, NP 8070, NP 8530, NP 8570, NP 8580, NP 9030, NP 9330, NP 9800  Charge NP 6085, NP 6285, NP 9085
FB2-2958-010	15017804 	<b>Charge Corona Grid</b>	CLC 1000, CLC 1000 S, CLC 3100, CLC 3900, CLC 4000, CLC 5000, CLC 5100
FB4-5117-000	15021043 	<b>Charge Corona Grid</b>	CLC 1100, CLC 1130, CLC 1150
FY1-0100-000	15375547 	<b>Corona Wire Spool</b> 50 m / Spool 80μ 0.3μ Gold Plated All Applications	FC 1, FC 2, FC 3, FC 3 II, FC 5, FC 5 II, FC 22, NP 1010, NP 1020, NP 6010, NP COLOR, PC 6, PC 7, PC 8, PC 10, PC 11, PC 12 (EU), PC 14, PC 20, PC 22, PC 24, PC 25
FB4-3687-000	15011002 	<b>Corona Wire Spool</b> 50 m / Spool 60μ Oxidized All Applications Except Grid  Charge	GP 555, GP 605, IMAGERUNNER C 6800, iR 85, iR 105, iR 5000, iR 5000 i, iR 5020 i, IR 5020 IN, iR 6000, iR 6000 i, IR 6020 I, iR 7200, iR 8500, IR C 6800, IR C 6800 N, NP 6317 NP 6045, NP 6050, NP 6050 ER, NP 6060, NP 6085, NP 6251, NP 6260, NP 6285, NP 6360, NP 7500

For use in  
**Canon**  
 Copiers

**Central/Eastern Europe**  
 Telephone: 31(0)183-696969  
 Fax: 31(0)183-629055  
 E-mail: order@edc.katun.com

OEM PN	KATUN PN	DESCRIPTION	MODEL NO.
<b>Corona/Charge/Transfer</b>			
RF5-2675-000 <i>Final Inventory</i>	15021569 ◆	<b>Transfer Roller</b> Gear included	iR 3250
RF9-1394-000 <i>Final Inventory</i>	15021569 ◆	<b>Transfer Charging Roller</b> Gear included	iR 3250
RF9-1394-000 <i>Final Inventory</i>	15019261	<b>Transfer Charging Roller Original</b>	iR 3250
RF9-1394-020 <i>Final Inventory</i>	15021569 ◆	<b>Transfer Charging Roller</b> Gear included	iR 3250
N/P/N	15375228 ◆	<b>Corona Wire Spool</b> Platinum alloy clad technology extends corona wire life. 60μ 7.5 m / Spool All Applications Except Grid	NP 120, NP 125, NP 126, NP 200, NP 210, NP 270, NP 271, NP 275, NP 300, NP 305, NP 400, NP 402, NP 500, NP 505, NP 5020, NP 5060, NP 6060, NP 6062, NP 6150, NP 6650, NP 6850, NP 6880, NP 6885, NP 7050, NP 7550, NP 8070, NP 8530, NP 8570, NP 8580, NP 9030, NP 9330, NP 9800
N/P/N	15008835 ◆	<b>Corona Wire</b> 60μ 0.3μ Gold Plated Precut corona wire designed for refurbishing convenience. Charge	NP 1015, NP 1215, NP 1318, NP 1510, NP 1520, NP 1530, NP 1550, NP 2010, NP 2020, NP 2120, NP 6020, NP 6116, NP 6216, NP 6220, NP 6221, NP 6318
FG5-1756-020 <i>Final Inventory</i>	15021521 ◆	<b>Transfer Charging Roller</b>	NP 6025, NP 6030
1189077-010	15375527 ◆	<b>Corona Wire Spool</b> 50 m / Spool Increased plating thickness enhances corona wire life. 60μ 1.5μ Gold Plated All Applications Except Grid	NP 6330

*Priced per Corona Wire, sold in Sets of 10.*















Central/Eastern Europe  
Telephone: 31(0)183-696969  
Fax: 31(0)183-629055  
E-mail: [order@edc.katun.com](mailto:order@edc.katun.com)

For use in  
**Canon**  
Copiers





OEM PN	KATUN PN	DESCRIPTION	MODEL NO.
<b>Electrical</b>			
RG5-1861-000 <i>Final Inventory</i>	15019285	Sensor Cable - PIU Original	iR 3250

For use in  
**Canon**  
 Copiers

**Central/Eastern Europe**  
 Telephone: 31(0)183-696969  
 Fax: 31(0)183-629055  
 E-mail: order@edc.katun.com













OEM PN	KATUN PN	DESCRIPTION	MODEL NO.
<b>Feed/Delivery</b>			
FA3-8733-040	15015626 	<b>Paper Feed Roller B</b>	BJ A1, BJ A1 S, CLC 1, CLC 500, NP 3525, NP 3725, NP 4040, NP 4335, NP 4540, NP 4835 i, NP 5020, NP 5060, NP 6060, NP 6062, NP 6150, NP 6650, NP 6835 RDF, NP 6850, NP 9800
FA3-8733-040	15636671 	<b>Paper Feed Roller B</b> Tire Only	BJ A1, BJ A1 S, CLC 1, CLC 500, NP 3525, NP 3725, NP 4040, NP 4540, NP 5020, NP 5060, NP 6060, NP 6062, NP 6150, NP 6650, NP 6835 RDF, NP 6850, NP 9800 <i>Priced per Tire, sold in Bags of 10.</i>
FF9-0581-030	15000893 	<b>Upper Paper Pickup Roller A</b> Tire Only	BJ A1, CLC 1, CLC 200, CLC 500, NP 3525, NP 3725, NP 4040, NP 4540, NP 5020, NP 5060, NP 6150, NP 6650, NP 6850 <i>Priced per Tire, sold in Bags of 10.</i>
FA4-8991-000	15000878 	<b>Separation Roller</b> Tire Only	CLC 1, CLC 200, CLC 300, CLC 500 <i>Priced per Tire, sold in Bags of 10.</i>
FF5-1838-000	15000892 	<b>Front Paper Pickup Roller</b> Tire Only	CLC 320, CLC 350 <i>Priced per Tire, sold in Bags of 10.</i>
FF5-1839-000	15000892 	<b>Rear Paper Pickup Roller</b> Tire Only	CLC 320, CLC 350 <i>Priced per Tire, sold in Bags of 10.</i>
FF5-1843-000	15636671 	<b>Paper Feed Roller</b> Tire Only	CLC 320, CLC 350 <i>Priced per Tire, sold in Bags of 10.</i>
FF5-1822-000	15000892 	<b>Paper Pickup Roller</b> Tire Only	CLC 550 <i>Priced per Tire, sold in Bags of 10.</i>
FF5-1829-000	15636671 	<b>Separation Roller</b> Tire Only	CLC 550 <i>Priced per Tire, sold in Bags of 10.</i>
FB2-0661-000	15019627 	<b>Oil Removing Roller</b>	CLC 700, CLC 700 E, CLC 700 L, CLC 700 S, CLC 800, CLC 800 S, CLC 900, CLC 920, CLC 950
FF5-2287-000	15012302 	<b>Multifeed Pickup Tire</b> Tire Only	CLC 700, CLC 700 E, CLC 700 L, CLC 700 S, CLC 800, CLC 800 S, CLC 900, CLC 920, CLC 950 <i>Priced per Tire, sold in Bags of 5.</i>
FB1-7061-000	15016779 	<b>Paper Feed Roller</b>	CLC 700, CLC 700 E, CLC 700 L, CLC 700 S, CLC 800, CLC 800 S, CLC 900, CLC 920, CLC 950, CLC 1000, CLC 1000 S, CLC 3100, GP 30 F, GP 55, GP 55 F, GP 55 II, NP 6025, NP 6028, NP 6030, NP 6035, NP 6035 F, NP 6330, CFU- B1, CFU- F1, CFU- F2, CFU- G1, CFU- H1, CFU- H2, CFU- N1, DU- A1, PDP- K1













OEM PN	KATUN PN	DESCRIPTION	MODEL NO.	
<b>Feed/Delivery</b>				
FB1-7061-000	15011264 	<b>Paper Feed Roller</b> Tire Only	CLC 700, CLC 700 E, CLC 700 L, CLC 700 S, CLC 800, CLC 800 S, CLC 900, CLC 920, CLC 950, CLC 1000, CLC 1000 S, CLC 3100, GP 30 F, GP 55, GP 55 F, GP 55 II, NP 6025, NP 6028, NP 6030, NP 6035, NP 6035 F, NP 6330, CFU- B1, CFU- F1, CFU- F2, CFU- G1, CFU- H1, CFU- H2, CFU- N1, DU- A1, PDP- K1	<i>Priced per Tire, sold in Bags of 10.</i>
FF5-1220-000	15017821 	<b>Paper Pickup Roller</b> Tire Only Rear  Front	CLC 700, CLC 700 E, CLC 700 L, CLC 700 S, CLC 800, CLC 800 S, CLC 1000, CLC 1000 S, GP 30 F, GP 55, GP 55 F, GP 55 II, NP 6045, NP 6251, NP 6260, NP 6330, NP 6360, NP 7500, PDP- K1  CLC 900, CLC 920, CLC 950, iR 5000, iR 5000 i, iR 5020 i, IR 5020 IN, iR 6000, iR 6000 i, IR 6020 I, NP 6025, NP 6028, NP 6030, NP 6035, NP 6035 F, NP 6050, NP 6050 ER, NP 6350, CFU- B1, CFU- F1, CFU- F2, CFU- G1, CFU- H1, CFU- H2, CFU- N1, DU- A1, PD- A1, PDP- A1	<i>Priced per Tire, sold in Bags of 10.</i>
FF5-1221-000	15017821 	<b>Paper Pickup Roller</b> Tire Only Front  Rear	CLC 700, CLC 700 E, CLC 700 L, CLC 700 S, CLC 800, CLC 800 S, CLC 1000, CLC 1000 S, GP 30 F, GP 55, GP 55 F, GP 55 II, NP 6045, NP 6251, NP 6260, NP 6330, NP 6360, NP 7500, PDP- K1  CLC 900, CLC 920, CLC 950, iR 5000, iR 5000 i, iR 5020 i, IR 5020 IN, iR 6000, iR 6000 i, IR 6020 I, NP 6025, NP 6028, NP 6030, NP 6035, NP 6035 F, NP 6050, NP 6050 ER, NP 6350, CFU- B1, CFU- F1, CFU- F2, CFU- G1, CFU- H1, CFU- H2, CFU- N1, DU- A1, PD- A1, PDP- A1	<i>Priced per Tire, sold in Bags of 10.</i>
FB1-7060-020	15016833 	<b>Separation Roller</b>	CLC 700, CLC 700 E, CLC 700 L, CLC 700 S, CLC 800, CLC 800 S, CLC 900, CLC 920, CLC 950, CLC 1000 S, CLC 1130, CLC 1150, CLC 3100, GP 30 F, GP 55, GP 55 F, GP 55 II, NP 6025, NP 6028, NP 6030, NP 6035, NP 6035 F, NP 6330, CFU- B1, CFU- F1, CFU- F2, CFU- G1, CFU- H1, CFU- H2, CFU- N1, DU- A1, PDP- K1	
FB1-7060-020	15012801 	<b>Separation Roller</b> Tire Only	CLC 700, CLC 700 E, CLC 700 L, CLC 700 S, CLC 800, CLC 800 S, CLC 900, CLC 920, CLC 950, CLC 1000 S, CLC 1130, CLC 1150, CLC 3100, GP 30 F, GP 55, GP 55 F, GP 55 II, NP 6025, NP 6028, NP 6030, NP 6035, NP 6035 F, NP 6330, CFU- B1, CFU- F1, CFU- F2, CFU- G1, CFU- H1, CFU- H2, CFU- N1, DU- A1, PDP- K1	<i>Priced per Tire, sold in Bags of 10.</i>

For use in  
**Canon**  
 Copiers

**Central/Eastern Europe**  
 Telephone: 31(0)183-696969  
 Fax: 31(0)183-629055  
 E-mail: order@edc.katun.com

OEM PN	KATUN PN	DESCRIPTION	MODEL NO.
<b>Feed/Delivery</b>			
N/P/N	15012619 	<b>Feed Tire Replacement Kit</b> Tire Only  Kit Contains: • (4) Paper Feed Tire • (4) Paper Pickup Tire • (4) Separation Tire	CLC 700, CLC 700 E, CLC 700 L, CLC 700 S, CLC 800, CLC 800 S, GP 30 F, GP 55, GP 55 F, GP 55 II, NP 6025, NP 6028, NP 6030, NP 6035, NP 6035 F, CFU- F1, CFU- G1, CFU- H1, DU- A1
FB2-0846-000	15020761 	<b>Paper Pickup Tire</b> Tire Only	CLC 800, CLC 800 S, CLC 900, CLC 920, CLC 950, CLC 1000, CLC 1000 S  <i>Priced per Tire, sold in Bags of 10.</i>
FB2-0847-000	15020762 	<b>Paper Feed Tire</b> Tire Only	CLC 800, CLC 800 S, CLC 900, CLC 920, CLC 950, CLC 1000, CLC 1000 S  <i>Priced per Tire, sold in Bags of 10.</i>
FB2-0848-000	15017777 	<b>Separation Tire</b> Tire Only	CLC 800, CLC 800 S, CLC 900, CLC 920, CLC 950, CLC 1000, CLC 1000 S  <i>Priced per Tire, sold in Bags of 10.</i>
FF5-2101-000	15020761 	<b>Front Paper Pickup Roller</b> Tire Only	CLC 800, CLC 800 S, CLC 900, CLC 920, CLC 950, CLC 1000, CLC 1000 S, CLC 1130, CLC 1150, CLC 3100  <i>Priced per Tire, sold in Bags of 10.</i>
FF5-2102-000	15020761 	<b>Rear Paper Pickup Roller</b> Tire Only	CLC 800, CLC 800 S, CLC 900, CLC 920, CLC 950, CLC 1000, CLC 1000 S, CLC 1130, CLC 1150, CLC 3100  <i>Priced per Tire, sold in Bags of 10.</i>
FF5-2103-000	15020762 	<b>Feed Roller</b> Tire Only	CLC 800, CLC 800 S, CLC 900, CLC 920, CLC 950, CLC 1000, CLC 1000 S, CLC 1150, CLC 3100  <i>Priced per Tire, sold in Bags of 10.</i>
FB2-0631-020 <i>Final Inventory</i>	15018562 	<b>Push-Up Roller</b>	CLC 900, CLC 920, CLC 950, CLC 1100, CLC 1130, CLC 1150  <i>Priced per Pickup Roller, sold in Bags of 10.</i>
FF5-4327-000	15020905 	<b>Paper Pickup Roller</b> Tire Only	CLC 1000, CLC 1000 S, CLC 1100, CLC 1130, CLC 1150, CLC 3100, CLC 3900, CLC 4000, CLC 5000, CLC 5100  <i>Priced per Tire, sold in Bags of 10.</i>
FF5-4331-000	15020157 	<b>Paper Feed Roller</b>	CLC 1000, CLC 1000 S, CLC 1100, CLC 1130, CLC 1150, CLC 3100, CLC 3900, CLC 4000, CLC 5000, CLC 5100
FF2-4710-000	15015626 	<b>Separation Roller C</b>	CLC 1000, CLC 1000 S, CLC 1100, CLC 1130, CLC 1150, CLC 3100, CLC 3900, CLC 4000, CLC 5000, CLC 5100, NP 5060, NP 6060, NP 6062, NP 6150, NP 6650, NP 6850, NP 9800
FF2-4710-000	15636671 	<b>Separation Roller C</b> Tire Only	CLC 1000, CLC 1000 S, CLC 1100, CLC 1130, CLC 1150, CLC 3100, CLC 3900, CLC 4000, CLC 5000, CLC 5100, NP 5060, NP 6060, NP 6062, NP 6150, NP 6650, NP 6850, NP 9800  <i>Priced per Tire, sold in Bags of 10.</i>
FB2-3201-000	15018690 	<b>Transfer Belt Cleaning Roller</b>	CLC 1000, CLC 1000 S, CLC 3100









OEM PN	KATUN PN	DESCRIPTION	MODEL NO.	
<b>Feed/Delivery</b>				
FB3-3228-010	15019626 	<b>Oil Removing Roller</b>	CLC 1000, CLC 1000 S, CLC 3100, CLC 3900, CLC 4000, CLC 5000, CLC 5100	
FF2-6312-000	15011084 	<b>Separation Roller</b> Tire Only	CLC 1000, CLC 1000 S, CLC 3100, CLC 3900, CLC 5000, NP 6085, NP 6285, PD- H1, PD- J1, PD- K1	<i>Priced per Tire, sold in Bags of 10.</i>
FF2-4785-020	15011083 	<b>Paper Feed Roller</b> Tire Only	CLC 1000, CLC 1000 S, CLC 3100, CLC 3900, CLC 5000, PD- H1, PD- J1, PD- K1	<i>Priced per Tire, sold in Bags of 10.</i>
FF2-5674-020	15011083 	<b>Paper Pickup Roller</b> Tire Only	CLC 1000, CLC 1000 S, CLC 3100, CLC 3900, CLC 5000, PD- H1, PD- J1, PD- K1	<i>Priced per Tire, sold in Bags of 10.</i>
FB4-5111-000 <i>Final Inventory</i>	15019625 	<b>Polishing Roller</b>	CLC 1100, CLC 1130, CLC 1150	
FF5-7829-000	15017821 	<b>Paper Pickup Roller</b> Tire Only Front	CLC 1100, CLC 1130, CLC 1150, CLC 4000, CLC 5000, CLC 5100, GP 555, GP 605, iR 85, iR 105, iR 7200, iR 8500, PD- B1, PD- C1, PD- L1, PD- M1, PD- P1, PD- R1	<i>Priced per Tire, sold in Bags of 10.</i>
FF5-7830-000	15017821 	<b>Paper Pickup Roller</b> Tire Only Rear	CLC 1100, CLC 1130, CLC 1150, CLC 4000, CLC 5000, CLC 5100, GP 555, GP 605, iR 85, iR 105, iR 7200, iR 8500, PD- B1, PD- C1, PD- L1, PD- M1, PD- P1, PD- R1	<i>Priced per Tire, sold in Bags of 10.</i>
FB2-7777-020	15021619 	<b>Separation Roller</b>	CLC 1100, CLC 1130, CLC 1150, GP 335, GP 405, GP 555, GP 605, iR 85, iR 400, iR 5000, iR 5000 i, iR 5020 i, IR 5020 IN, iR 6000, iR 6000 i, IR 6020 I, iR 7200, iR 8500, NP 6045, NP 6050, NP 6050 ER, NP 6085, NP 6251, NP 6260, NP 6285, NP 6350, NP 6360, NP 7500, NP 9085, PD- A1, PD- B1, PD- C1, PD- F1, PD- L1, PD- M1, PD- P1, PD- R1, PDP- A1	
FB4-2034-000	15018877 	<b>Paper Pickup/Feed Roller</b> Tire Only	CLC 3900, CLC 4000, CLC 5000, CLC 5100, GP 335, GP 405, GP 555, GP 605, iR 85, iR 400, iR 7200, iR 8500, PD- B1, PD- C1, PD- F1, PD- L1	<i>Priced per Tire, sold in Bags of 6.</i>
FB4-2033-000	15017821 	<b>Paper Pickup Roller</b> Tire Only	CLC 3900, CLC 4000, CLC 5000, CLC 5100, GP 335, GP 405, GP 555, GP 605, iR 400, PD- B1, PD- C1, PD- F1, PD- L1	<i>Priced per Tire, sold in Bags of 10.</i>
FB5-6586-000	15021947 	<b>Separation Roller</b>	CLC 3900, CLC 4000, CLC 5000, CLC 5100, iR 105	













For use in  
**Canon**  
 Copiers

**Central/Eastern Europe**  
 Telephone: 31(0)183-696969  
 Fax: 31(0)183-629055  
 E-mail: order@edc.katun.com

OEM PN	KATUN PN	DESCRIPTION	MODEL NO.
<b>Feed/Delivery</b>			
FB1-8581-000	15012302 	<b>Bypass Feed Roller</b> Tire Only Various Applications  Manual	IMAGERUNNER C 3100, IMAGERUNNER C 3100 N, IMAGERUNNER C 6800, IR C 3100, IR C 6800, IR C 6800 N, PC 720, PC 740, PC 745, PC 750, PC 775, PC 780  GP 30 F, GP 55, GP 55 F, GP 55 II, GP 210, GP 215, GP 220, GP 225, GP 285, GP 335, GP 405, iR 400, iR 2200, iR 2200 i, iR 2800, IR 2800 I, IR 3300, iR 3300 i, iR 5000, iR 5000 i, iR 5020 i, IR 5020 IN, iR 6000, iR 6000 i, IR 6020 I, IR C 2100, iR C 2100 S, iR C 2105, iR C 3200, IR C 3200 N, IR C 3200 S, NP 2120, NP 6012, NP 6016, NP 6025, NP 6028, NP 6030, NP 6035, NP 6035 F, NP 6112, NP 6212, NP 6218, NP 6221, NP 6312, NP 6317, NP 6330, NP 6521, NP 7160, NP 7161, NP 7164, S 3200, PD- B1
			<i>Priced per Tire, sold in Bags of 5.</i>
FA9-0240-000	15016742 	<b>Exit Tire</b>	GP 30 F, GP 55, GP 55 F, GP 55 II, NP 150, NP 155, NP 155 DF, NP 3025, NP 3050, NP 3225, NP 3525, NP 3725, NP 4050, NP 4080, NP 4335, NP 4835, NP 4835 i, NP 6025, NP 6028, NP 6030, NP 6035, NP 6035 F, NP 6241, NP 6330, NP 6831, NP 6835 RDF
			<i>Priced per Tire, sold in Bags of 10.</i>
RF5-2490-000	15020871 	<b>Paper Feed/Separation Roller</b>	GP 160, GP 160 F, NP 7160, NP 7161, NP 7164, CFM- C1, CFM- D1, CFM- E1
			<i>Priced per Feed/Sep Roller, sold in Bags of 6.</i>
RB1-8865-000	15020846 	<b>Paper Pickup Roller</b> Half moon shape	GP 160, GP 160 F, CFM- D1, CFM- E1
			<i>Priced per Pickup Roller, sold in Bags of 10.</i>
FF5-4552-020	15017942 	<b>Paper Pickup Roller</b> Tire Only	GP 210, GP 215, GP 220, GP 225, GP 285, GP 335, GP 405, iR 400, iR 2200, iR 2200 i, iR 2800, IR 2800 I, iR 3300, iR 3300 i, IR C 2100, iR C 2100 S, iR C 2105, CFU- L1, CFU- M1, CFU- R1, CFU- S1, CFU- U1, CFU- W1
			<i>Priced per Tire, sold in Bags of 10.</i>
FF5-4634-020	15022735 	<b>Separation Roller</b>	GP 210, GP 215, GP 220, GP 225, GP 285, GP 335, GP 405, iR 400, iR 2200, iR 2200 i, iR 2800, IR 2800 I, iR 3300, iR 3300 i, IR C 2100, iR C 2100 S, iR C 2105, CFU- L1, CFU- M1, CFU- R1, CFU- S1, CFU- U1, CFU- W1, PD- L1
			<i>Priced per Feed/Sep Roller, sold in Bags of 2.</i>
FF5-4634-020	15017941 	<b>Separation Roller</b> Tire Only	GP 210, GP 215, GP 220, GP 225, GP 285, GP 335, GP 405, iR 400, iR 2200, iR 2200 i, iR 2800, IR 2800 I, iR 3300, iR 3300 i, IR C 2100, iR C 2100 S, iR C 2105, CFU- L1, CFU- M1, CFU- R1, CFU- S1, CFU- U1, CFU- W1, PD- L1
			<i>Priced per Tire, sold in Bags of 10.</i>













OEM PN	KATUN PN	DESCRIPTION	MODEL NO.	
<b>Feed/Delivery</b>				
N/P/N	15021849 	<b>Feed Tire Replacement Kit</b> Tire Only  Kit Contains: • (4) Paper Feed Tire • (2) Separation Tire	GP 210, GP 215, GP 220, GP 225, GP 285, GP 335, GP 405, iR 400, iR 2200, iR 2800, iR 3300, IR C 2100, iR C 2100 S, iR C 2105, CFU- L1, CFU- M1, CFU- R1, CFU- S1, CFU- U1, CFU- W1	
RB1-6588-000 <i>Final Inventory</i>	15020156	<b>Torque Limiter Original</b>	GP 210, GP 215, GP 220, GP 225, GP 335, GP 405, iR 400, iR 2200, iR 2200 i, iR 2800, IR 2800 I, iR 3300, iR 3300 i	
N/P/N	15021762 	<b>Feed Tire Replacement Kit</b> For DeckimageRUNNER 330/400 For Deck/CassetteimageRUNNER 550/600 Kit Contains: • (2) Paper Pickup Tire • (2) Paper Feed Tire • (1) Separation Roller	GP 335, GP 405, GP 555, GP 605, iR 85, iR 400, iR 7200, iR 8500, PD- F1, PD- L1	
FE5-4132-000	15022908 	<b>Manual Feed Separation Pad</b>	GP 335, GP 405, iR 400, iR 2200, IR 2200 i, IR 2800, IR 2800 I, iR 3300, iR 3300 i, NP 7160, NP 7161, NP 7164, PD- B1	
FG6-2748-000	15020554 	<b>ADF Feed Roller Assembly</b> Tire Only Ribbed Tire	GP 555, GP 605	<i>Priced per Tire, sold in Bags of 12.</i>
FB4-2035-000	15017776 	<b>Paper Pickup/Feed Roller</b> Tire Only	GP 555, GP 605, iR 85, iR 105, iR 7200, iR 8500	<i>Priced per Tire, sold in Bags of 10.</i>
FB2-7545-000	15021650 	<b>Sponge Roller</b> Various Applications  Separation	NP 6045, NP 6050, NP 6050 ER, NP 6251, NP 6260, NP 6350, NP 6360, NP 7500 GP 555, GP 605, iR 85, iR 105, iR 7200, iR 8500	
FB4-7640-000	15022683 	<b>ADF Pickup Roller</b> Tire Only	GP 555, GP 605, iR 85, iR 105, iR 8500	<i>Priced per Tire, sold in Bags of 8.</i>
FE6-3059-000	15015001 	<b>Paper Feed Belt</b>	GP 555, GP 605, iR 85, iR 105, iR 8500, DADF- A1, RDF- 1, RDF- G1, RDF- H1	<i>Priced per Belt, sold in Packages of 3.</i>
FE6-3059-000	15023494 	<b>Paper Feed Belt</b> OEM style With center ridge	GP 555, GP 605, iR 85, iR 105, iR 8500, DADF- A1, RDF- 1, RDF- G1, RDF- H1	<i>Priced per Feed Belt, sold in Bags of 11.</i>
FB4-6991-000	15013735 	<b>Paper Pickup/Separation Roller</b> Tire Only Ribbed Tire	GP 555, GP 605, DADF- A1, DADF- G1, RDF- E3	<i>Priced per Tire, sold in Bags of 12.</i>

For use in  
**Canon**  
Copiers

**Central/Eastern Europe**  
Telephone: 31(0)183-696969  
Fax: 31(0)183-629055  
E-mail: order@edc.katun.com

OEM PN	KATUN PN	DESCRIPTION	MODEL NO.	
<b>Feed/Delivery</b>				
FF9-1763-000	15017821 	<b>Bypass Pickup Roller</b> Tire Only Front	iR 85, iR 105, iR 7200, iR 8500	<i>Priced per Tire, sold in Bags of 10.</i>
FF9-1764-000	15017821 	<b>Bypass Pickup Roller</b> Tire Only Rear	iR 85, iR 105, iR 7200, iR 8500	<i>Priced per Tire, sold in Bags of 10.</i>
RF5-1834-000	15014243 	<b>Feed/Separation Roller</b>	iR 3250, PD- D1, PD- N1	<i>Priced per Feed/Sep Roller, sold in Bags of 6.</i>
FB5-3435-000	15020768 	<b>Paper Feed Tire</b> Tire Only Ribbed Tire	iR 5000, iR 5000 i, iR 5020 i, IR 5020 IN, iR 6000, iR 6000 i, IR 6020 I	<i>Priced per Tire, sold in Bags of 8.</i>
FF5-9779-000	15020768 	<b>Paper Pickup/Feed Roller</b> Tire Only Ribbed Tire	iR 5000, iR 5000 i, iR 5020 i, IR 5020 IN, iR 6000, iR 6000 i, IR 6020 I	<i>Priced per Tire, sold in Bags of 8.</i>
FF2-0017-000	15016096 	<b>Paper Pickup Roller</b>	NP 1015, NP 1215, NP 1510, NP 1520, NP 6318	<i>Priced per Pickup Roller, sold in Bags of 10.</i>
FA6-5547-000	15012718 	<b>Paper Pickup Tire</b> Tire Only	NP 2020, NP 2120, NP 3020, NP 3030, NP 3050, NP 6221, NP 6831, CFU- C1, CFU- E1	<i>Priced per Tire, sold in Bags of 10.</i>
FA9-1363-000	15012799 	<b>Paper Pickup Tire</b> Tire Only Ribbed Tire	NP 3025, NP 3225	<i>Priced per Tire, sold in Bags of 10.</i>
FF2-2388-000	15015256 	<b>Upper Paper Pickup Roller</b>	NP 3325, NP 3825, NP 3825 II, NP 6825 DADF, NP 6826 DADF	<i>Priced per Roller, sold in Bags of 6.</i>
FA5-2854-030	15000888 	<b>Paper Pickup Tire</b> Tire Only	NP 4050, NP 4080, NP 4335, NP 4835, NP 4835 i, NP 6060, NP 6062, NP 6241, NP 6835 RDF, NP 9800, CFU- D1, PD- 8, PDP- D1	<i>Priced per Tire, sold in Bags of 10.</i>
FF9-1113-030	15000888 	<b>Paper Pickup Roller</b> Tire Only Various Applications  Bypass	NP 4050, NP 4080, NP 4335, NP 4835, NP 4835 i, NP 6062, NP 6241, NP 6835 RDF, CFU- D1, CFU- F1, PD- 8, PDP- D1, PDP- E1 NP 6060	<i>Priced per Tire, sold in Bags of 10.</i>
FA5-2867-020	15012800 	<b>Separation Roller</b> Tire Only	NP 4050, NP 4080, NP 4335, NP 4835, NP 4835 i, NP 6241, NP 6835 RDF, CFU- D1	<i>Priced per Tire, sold in Bags of 10.</i>
FA5-2933-020	15015626 	<b>Paper Feed Roller</b>	NP 4050, NP 4080, NP 4335, NP 4835, NP 4835 i, NP 6241, NP 6835 RDF, CFU- D1	
FA5-2933-020	15012221 	<b>Paper Feed Roller</b> Tire Only	NP 4050, NP 4080, NP 4335, NP 4835, NP 4835 i, NP 6241, NP 6835 RDF, CFU- D1	<i>Priced per Tire, sold in Bags of 10.</i>















OEM PN	KATUN PN	DESCRIPTION	MODEL NO.	
<b>Feed/Delivery</b>				
N/P/N	15012618 	<b>Feed Tire Replacement Kit</b> Tire Only Kit Contains: • (4) Paper Feed Tire • (4) Paper Pickup Tire • (4) Separation Tire	NP 4050, NP 4080, NP 4335, NP 4835, NP 4835 i, NP 6241, NP 6835 RDF, CFU- D1	
FF9-1003-050	15000888 	<b>Paper Feed Roller A</b> Tire Only	NP 4050, NP 4080, NP 4335, NP 4835, NP 4835 i, NP 6241, NP 6835 RDF, CFU- D1, PD- 8, PDP- C1, PDP- J1	<i>Priced per Tire, sold in Bags of 10.</i>
FA5-4534-020	15000884 	<b>Duplex Paper Feed Tire</b> Tire Only	NP 5060, NP 6650, NP 6850	<i>Priced per Tire, sold in Bags of 10.</i>
FF3-1439-000	15000894 	<b>Duplex Separation Roller</b> Tire Only	NP 5060, NP 6650, NP 6850	<i>Priced per Tire, sold in Bags of 10.</i>
FA5-3449-020	15000881 	<b>Paper Feed Tire</b> Tire Only Duplex Pickoff Separation/Feed	NP 5060, NP 6650, NP 6850, NP 6880, NP 8580 NP 9800	<i>Priced per Tire, sold in Bags of 10.</i>
FC2-3309-000	15000881 	<b>Paper Feed Tire</b> Tire Only Duplex Pickoff Separation/Feed	NP 5060, NP 6650, NP 6850, NP 6880, NP 8580 NP 9800	<i>Priced per Tire, sold in Bags of 10.</i>
FB2-7522-000	15014060 	<b>Manual Paper Feed Roller</b> Tire Only	NP 6045, NP 6050, NP 6050 ER, NP 6251, NP 6260, NP 6350, NP 6360, NP 7500	<i>Priced per Tire, sold in Bags of 10.</i>
FA5-5427-000	15015001 	<b>Paper Feed Belt</b>	NP 6045, NP 6050, NP 6050 ER, NP 6251, NP 6260, NP 6350, NP 6360, NP 7500, ADF- A1, ADF- C1, ADF- D1, ADF- E1, D- ADF, RDF- 2, RDF- 2 N, RDF- 3, RDF- A1, RDF- B1, RDF- C1, RDF- D1, RDF- E1, RDF- F1	<i>Priced per Belt, sold in Packages of 3.</i>
FB2-7695-000	15017777 	<b>Paper Feed Roller</b> Tire Only	NP 6045, NP 6050, NP 6050 ER, NP 6251, NP 6260, NP 6350, NP 6360, NP 7500, PD- A1, PDP- A1	<i>Priced per Tire, sold in Bags of 10.</i>
N/P/N	15021706 	<b>Feed Tire Replacement Kit</b> Kit Contains: • (2) Paper Feed Tire • (2) Paper Pickup Tire • (1) Separation Roller	NP 6045, NP 6050, NP 6050 ER, NP 6251, NP 6260, NP 6350, NP 6360, NP 7500, PDP- A1	
FC2-1532-000	15015611 	<b>Paper Pickup Roller</b> Various Applications  Original	NP 6045, NP 6050, NP 6050 ER, NP 6251, NP 6260, NP 6350, NP 6360, NP 7500 RDF- D1, RDF- E1, RDF- E2, RDF- E3	<i>Priced per Pickup Roller, sold in Bags of 4.</i>



For use in  
**Canon**  
 Copiers













**Central/Eastern Europe**  
 Telephone: 31(0)183-696969  
 Fax: 31(0)183-629055  
 E-mail: order@edc.katun.com

OEM PN	KATUN PN	DESCRIPTION	MODEL NO.
<b>Feed/Delivery</b>			
FC2-1533-000	15013735 	<b>Paper Pickup/Separation Roller</b> Tire Only Ribbed Tire	NP 6045, NP 6050, NP 6050 ER, NP 6251, NP 6260, NP 6350, NP 6360, NP 7500, RDF- D1, RDF- E1, RDF- E2, RDF- G1, RDF- H1  <i>Priced per Tire, sold in Bags of 12.</i>
FA6-7704-000	15012221 	<b>Separation Tire</b> Tire Only	NP 6060, NP 6062  <i>Priced per Tire, sold in Bags of 10.</i>
FA6-8090-020	15011084 	<b>Separation Tire</b> Tire Only	NP 6060, NP 6062  <i>Priced per Tire, sold in Bags of 10.</i>
FC1-5637-000	15012168 	<b>Paper Feed Tire</b> Tire Only Ribbed Tire	NP 6060, NP 6062  <i>Priced per Tire, sold in Bags of 10.</i>
FC1-9410-000	15011084 	<b>Separation Tire</b> Tire Only	NP 6060, NP 6062  <i>Priced per Tire, sold in Bags of 10.</i>
FF3-0067-000	15020114 	<b>Separation Roller</b>	NP 6060, NP 6062
N/P/N	15021488 	<b>Front Tray Feed Tire Replacement Kit</b> with Sponge Rollers Kit Contains: • (4) Paper Pickup Tire • (4) Paper Feed Tire • (2) Separation Roller	NP 6060, NP 6062
N/P/N	15021489 	<b>Side Tray Feed Tire Replacement Kit</b> Kit Contains: • (2) Paper Pickup Tire • (2) Paper Feed Tire • (1) Separation Roller	NP 6060, NP 6062
FA6-7777-020	15011064 	<b>Paper Pickup Roller</b> Tire Only	NP 6060, NP 6062, NP 6085, NP 6285, NP 9085  <i>Priced per Tire, sold in Bags of 10.</i>
FA6-8089-000	15011083 	<b>Paper Pickup Roller</b> Tire Only	NP 6060, NP 6062, NP 6085, NP 6285, NP 9085  <i>Priced per Tire, sold in Bags of 10.</i>
FA6-8089-020	15011083 	<b>Paper Feed Tire</b> Tire Only	NP 6060, NP 6062, NP 6085, NP 6285, NP 9085  <i>Priced per Tire, sold in Bags of 10.</i>
FB2-9269-000	15022033 	<b>Separation Roller</b>	NP 6085, NP 6285, NP 9085
FB3-9699-000	15017022 	<b>Separation Tire</b>	NP 6085, NP 6285, NP 9085  <i>Priced per Tire, sold in Bags of 10.</i>





Katun Performance Product

© 2004 Katun Corporation













OEM PN	KATUN PN	DESCRIPTION	MODEL NO.	
<b>Feed/Delivery</b>				
FA3-2615-020	15012799 	<b>Paper Pickup Tire</b> Tire Only Ribbed Tire	NP 6880, NP 6885, NP 7050, NP 7550, NP 8070, NP 8530, NP 8570, NP 8580, NP 9800, PD- 1, PD- 2, PD- 3, PD- 4, PD- 5	<i>Priced per Tire, sold in Bags of 10.</i>
FA5-5598-030	15000885 	<b>Duplex Separation Tire</b> Tire Only	NP 6880, NP 8580, NP 9800	<i>Priced per Tire, sold in Bags of 10.</i>
FL9-0077-000	15000896 	<b>Paper Feed Roller</b> Tire Only	NP 6885, NP 8530	<i>Priced per Tire, sold in Bags of 10.</i>
FL9-0077-020	15000896 	<b>Paper Feed Roller</b> Tire Only	NP 6885, NP 8530	<i>Priced per Tire, sold in Bags of 10.</i>
FL9-0078-030	15000897 	<b>Separation Roller</b> Tire Only	NP 6885, NP 8530	<i>Priced per Tire, sold in Bags of 10.</i>
FL9-0070-020	15000895 	<b>Paper Feed Roller</b> Tire Only	NP 6885, NP 8530, NP 9800	<i>Priced per Tire, sold in Bags of 10.</i>
FL9-0070-030	15000895 	<b>Paper Feed Roller</b> Tire Only	NP 6885, NP 8530, NP 9800	<i>Priced per Tire, sold in Bags of 10.</i>
FL9-0009-030	15000886 	<b>Paper Feed Roller</b> Tire Only Various Applications  Duplex	CFU- F1, PD- 5, PDP- C1, PDP- D1, PDP- E1, PDP- J1 NP 6885, NP 8530, NP 9800	<i>Priced per Tire, sold in Bags of 10.</i>
FA5-7789-000	15012798 	<b>Paper Pickup Tire</b> Tire Only Ribbed Tire	NP 6885, NP 8530, PD- 5	<i>Priced per Tire, sold in Bags of 10.</i>
FE9-0019-000	15000886 	<b>Paper Pickup/Feed Tire</b> Tire Only	NP 9800, PD- 8	<i>Priced per Tire, sold in Bags of 10.</i>
429727 <b>Final Inventory</b>	15019646 	<b>Nip Roller</b>	NP 9850	
N/P/N	15014798 	<b>Document Feeder Replacement Kit</b> Kit Contains: • (2) Paper Pickup Tire • (9) Original Feed Tire • (6) Separation Belt	ADF- A1	
FA5-4654-040	15011368 	<b>Original Separation Roller</b> Tire Only Crepe Tire	ADF- A1, ADF- C1, ADF- D1, ADF- E1, D- ADF	<i>Priced per Tire, sold in Bags of 9.</i>

For use in  
**Canon**  
 Copiers

**Central/Eastern Europe**  
 Telephone: 31(0)183-696969  
 Fax: 31(0)183-629055  
 E-mail: order@edc.katun.com





OEM PN	KATUN PN	DESCRIPTION	MODEL NO.	
<b>Feed/Delivery</b>				
FE6-3036-000	15019854 	<b>Original Separation Roller</b> Tire Only Ribbed Tire	ADF- A1, ADF- C1, ADF- D1, ADF- E1, D- ADF	<i>Priced per Tire, sold in Bags of 9.</i>
FA3-4686-020	15636731 	<b>Paper Pickup Roller</b>	ADF- A1, D- ADF, RDF- 1, RDF- B1, RDF- C1, RDF- F1	<i>Priced per Roller, sold in Bags of 10.</i>
1165547-000	15012718 	<b>Paper Pickup Tire</b> Tire Only	CFU- C1	<i>Priced per Tire, sold in Bags of 10.</i>
FL9-0010-020	15018018 	<b>Paper Feed Roller C</b>	CFU- F1, PDP- C1, PDP- D1, PDP- E1, PDP- J1	
FL9-0010-020	15000880 	<b>Paper Feed Roller C</b> Tire Only	CFU- F1, PDP- C1, PDP- D1, PDP- E1, PDP- J1	<i>Priced per Tire, sold in Bags of 10.</i>
FB3-5702-000	15019841 	<b>Separation Belt</b>	DADF- A1, RDF- G1	<i>Priced per Belt, sold in Bags of 10.</i>
FC3-0607-000	15020161 	<b>ADF Feed Roller</b> Tire Only	DADF- D1	<i>Priced per Tire, sold in Bags of 10.</i>
FC3-0722-000	15022684 	<b>ADF Pickup Roller</b> Tire Only	DADF- D1	<i>Priced per Tire, sold in Bags of 10.</i>
FF6-1291-000	15023071 	<b>Separation Pad</b>	DADF- H1	
FA6-1038-020	15000892 	<b>Separation Tire</b> Tire Only	PD- 5	<i>Priced per Tire, sold in Bags of 10.</i>
N/P/N	15012653 	<b>Feed Tire Replacement Kit</b> Tire Only Kit Contains: • (2) Paper Feed Tire • (2) Paper Pickup Tire • (2) Separation Tire	PD- 5	
FA5-3466-020	15000880 	<b>Separation Tire</b> Tire Only	PD- 8	<i>Priced per Tire, sold in Bags of 10.</i>
N/P/N	15012313 	<b>Paper Feed Tire Kit</b> Kit Contains: • (2) Paper Feed Tire • (2) Separation Tire • (2) Paper Pickup Tire	PD- 8, PDP- C1, PDP- D1, PDP- E1	

















OEM PN	KATUN PN	DESCRIPTION	MODEL NO.	
<b>Feed/Delivery</b>				
RF5-1835-000	15022338 	<b>Pickup Roller</b>	PD- D1, PD- N1	<i>Priced per Pickup Roller, sold in Bags of 2.</i>
FA3-4598-020	15015001 	<b>Paper Feed Belt</b>	RDF- 1	<i>Priced per Belt, sold in Packages of 3.</i>
FA5-5410-000	15011549 	<b>Original Pickup Roller</b>	RDF- 2, RDF- 2 N, RDF- 3, RDF- A1	<i>Priced per Roller, sold in Bags of 2.</i>
FA5-5416-000	15011368 	<b>Original Feed Roller Unit</b> Tire Only Crepe Tire	RDF- 2, RDF- 2 N, RDF- 3, RDF- A1	<i>Priced per Tire, sold in Bags of 9.</i>
FF2-9926-000	15014698 	<b>Original Feed Roller Unit</b> Ribbed Tire	RDF- 2, RDF- 2 N, RDF- 3, RDF- A1	
FF2-9926-000	15019854 	<b>Original Feed Roller Unit</b> Tire Only Ribbed Tire	RDF- 2, RDF- 2 N, RDF- 3, RDF- A1	<i>Priced per Tire, sold in Bags of 9.</i>
FA5-5392-000	15011334 	<b>Reverse Roller Unit</b> Tire Only	RDF- 2, RDF- 3, RDF- A1	<i>Priced per Tire, sold in Bags of 4.</i>
N/P/N	15011753 	<b>Document Feeder Replacement Kit</b> Kit Contains: • (6) Separation Belt • (4) Reverse Tire • (9) Original Feed Tire • (2) Original Pickup Roller	RDF- 2, RDF- 3, RDF- A1	
N/P/N	15012139 	<b>Document Feeder Replacement Kit</b> Kit Contains: • (9) Original Feed Tire • (2) Original Pickup Roller • (6) Separation Belt	RDF- 2, RDF- 3, RDF- A1	
FA6-8686-000	15011368 	<b>Original Feed Roller</b> Tire Only Crepe Tire	RDF- A1	<i>Priced per Tire, sold in Bags of 9.</i>
FE6-3035-000	15014787 	<b>Original Feed Roller</b> Ribbed Tire	RDF- B1	
FC1-1259-000	15011369 	<b>Original Feed Roller</b> Tire Only	RDF- B1, RDF- C1, RDF- F1	<i>Priced per Tire, sold in Bags of 12.</i>
FE6-3035-020	15014787 	<b>Original Feed Roller</b> Ribbed Tire	RDF- B1, RDF- C1, RDF- F1	

For use in  
**Canon**  
 Copiers

**Central/Eastern Europe**  
 Telephone: 31(0)183-696969  
 Fax: 31(0)183-629055  
 E-mail: order@edc.katun.com













OEM PN	KATUN PN	DESCRIPTION	MODEL NO.
<b>Feed/Delivery</b>			
FE6-3035-020	15020554 	<b>Original Feed Roller</b> Tire Only Ribbed Tire	RDF- B1, RDF- C1, RDF- F1  <i>Priced per Tire, sold in Bags of 12.</i>
N/P/N	15012976 	<b>Document Feeder Replacement Kit</b> Kit Contains: • (9) Separation Belt • (12) Original Feed Tire • (2) Original Pickup Roller	RDF- B1, RDF- C1, RDF- F1
FC2-1345-000	15021649 	<b>Reverse Roller</b> Tire Only	RDF- D1, RDF- E1  <i>Priced per Tire, sold in Bags of 5.</i>
FF3-0115-000	15017008 	<b>Separation Flapper</b> Right	RDF- D1, RDF- E1
FF3-0117-000	15017009 	<b>Separation Flapper</b> Left	RDF- D1, RDF- E1



OEM PN	KATUN PN	DESCRIPTION	MODEL NO.
<b>Filters</b>			
FB2-4396-020	15018557 	<b>Ozone Filter</b>	CLC 200, CLC 300, CLC 320, CLC 350, CLC 700, CLC 700 E, CLC 700 L, CLC 700 S, CLC 800, CLC 800 S, CLC 900, CLC 920, CLC 950
FB2-4397-020	15018558 	<b>Ozone Filter</b>	CLC 700, CLC 700 E, CLC 700 L, CLC 700 S, CLC 800, CLC 800 S, CLC 900, CLC 920, CLC 950, CLC 1100, CLC 1130, CLC 1150
FB2-3703-000	15019640 	<b>Ozone Filter 2</b> Paper Type	CLC 1000, CLC 1000 S, CLC 3100
FB2-3702-000	15019639 	<b>Ozone Filter 1</b> Paper Type	CLC 1000, CLC 1000 S, CLC 3100, CLC 3900, CLC 4000, CLC 5000, CLC 5100
FB2-3704-000	15019741 	<b>Ozone Filter 3</b> Paper Type	CLC 1000, CLC 1000 S, CLC 3100, CLC 3900, CLC 4000, CLC 5000, CLC 5100
FB2-3955-000	15018863 	<b>Dust Filter</b>	CLC 1000, CLC 1000 S, CLC 3100, CLC 3900, CLC 4000, CLC 5000, CLC 5100
			<i>Priced per Filter, sold in Bags of 3.</i>
FB2-4114-000 <i>Final Inventory</i>	15018762 	<b>Oil Filter</b>	CLC 1000, CLC 1000 S, CLC 3100, CLC 3900, CLC 4000, CLC 5000, CLC 5100
FB3-5608-020	15020062 	<b>Air Filter</b>	CLC 1000, CLC 1000 S, CLC 3100, CLC 3900, CLC 4000, CLC 5000, CLC 5100
			<i>Priced per Filter, sold in Bags of 2.</i>
FA6-4538-000 <i>Final Inventory</i>	15018862 	<b>Air Filter 1</b>	CLC 1000, CLC 1000 S, CLC 3100, CLC 3900, CLC 4000, CLC 5000, CLC 5100, NP 6060, NP 6062, NP 6085, NP 6285, NP 6885, NP 8530, NP 9085, NP 9800
			<i>Priced per Filter, sold in Bags of 7.</i>
FB4-4819-000	15021756 	<b>Air Filter</b>	CLC 1100, CLC 1130, CLC 1150
FA6-5622-020	15012032 	<b>Ozone Filter</b>	NP 1015, NP 1215, NP 1318, NP 1510, NP 1520, NP 2010, NP 2020, NP 2120, NP 3020, NP 6221, NP 6318
FA5-1748-000	15011576 	<b>Ozone Filter</b>	NP 1015, NP 1215, NP 1318, NP 1510, NP 1520, NP 2010, NP 6318
FA5-4089-000	15015655 	<b>Ozone Filter</b>	NP 5020, NP 5060, NP 6150, NP 6650, NP 6850
FB2-7971-000	15015886 	<b>Ozone Filter 2</b>	NP 6045, NP 6050, NP 6050 ER, NP 6251, NP 6260, NP 6350, NP 6360, NP 7500

For use in  
**Canon**  
Copiers

**Central/Eastern Europe**  
Telephone: 31(0)183-696969  
Fax: 31(0)183-629055  
E-mail: order@edc.katun.com

OEM PN	KATUN PN	DESCRIPTION	MODEL NO.
<b>Fuser Cleaning</b>			
FA3-8908-000	15636505 	<b>Web Supply Roller</b> Universal Various Applications	GP 30 F, GP 55, GP 55 F, GP 55 II, GP 335, GP 405, iR 400, NP 3025, NP 3030, NP 3050, NP 3225, NP 3325, NP 3525, NP 3725, NP 3825, NP 3825 II, NP 4050, NP 4080, NP 4335, NP 4835, NP 4835 i, NP 6025, NP 6028, NP 6030, NP 6035, NP 6035 F, NP 6045, NP 6050, NP 6050 ER, NP 6241, NP 6251, NP 6260, NP 6330, NP 6350, NP 6360, NP 6825 DADF, NP 6826 DADF, NP 6831, NP 6835 RDF, NP 7500  Upper CLC 1
FB2-3482-000	15016718 	<b>Upper Web Supply Roller</b>	CLC 200, CLC 300, CLC 350, CLC 500, CLC 550, CLC 700, CLC 700 E, CLC 700 L, CLC 700 S, CLC 800, CLC 800 S, CLC 900, CLC 920, CLC 950
FB3-9463-000	15018691 	<b>Upper Web Supply Roller</b>	CLC 900, CLC 920, CLC 950, CLC 1000, CLC 1000 S, CLC 3100, CLC 3900, CLC 4000, CLC 5000, CLC 5100
FB3-7088-000	15018389 	<b>Cleaning Web</b>	CLC 1000, CLC 1000 S, CLC 3100, CLC 3900, CLC 4000, CLC 5000, CLC 5100
FB4-4543-000	15018833 	<b>Web Supply Roller</b>	CLC 1100, CLC 1130, CLC 1150
FF5-9084-000	15021739 	<b>Oil Application Plate</b>	CLC 1100, CLC 1130, CLC 1150
FG5-0018-080	15147241 	<b>Fuser Roller Cleaning Felt Assembly</b> Felt Only	FC 3, FC 3 II, FC 5, FC 5 II, PC 6, PC 7, PC 8, PC 11
FB4-0953-000	15018662 	<b>Lower Fuser Cleaning Roller</b>	GP 210, GP 215, GP 220, GP 225
FY1-1157-000	15018455 	<b>Web Supply Roller</b>	GP 555, GP 605, iR 85, iR 105, iR 5000, iR 5000 i, iR 5020 i, IR 5020 IN, iR 6000, iR 6000 i, IR 6020 I, iR 7200, iR 8500, NP 5060, NP 6650, NP 6850
FB5-1630-000	15021817 	<b>Web Supply Roller</b>	IR C 2100, iR C 2100 S, iR C 2105
FF1-2538-060	15636505 	<b>Web Supply Roller</b> Universal	NP 400, NP 402, NP 500, NP 505, NP 4040, NP 4540, NP 7050, NP 7550, NP 8070, NP 8570
FG5-0631-000	15147241 	<b>Fuser Roller Cleaning Felt</b> Felt Only	NP 1010, NP 1020, NP 6010
FA5-1952-000	15021708 	<b>Oil Roller FIBRA™</b>	NP 1015, NP 1215, NP 1318, NP 1510, NP 1520, NP 1530, NP 1550, NP 2010, NP 6116, NP 6216, NP 6317, NP 6318















*Priced per Felt,  
sold in Packages of 10.*

*Priced per Felt,  
sold in Packages of 10.*



Katun Performance Product

© 2004 Katun Corporation

OEM PN	KATUN PN	DESCRIPTION	MODEL NO.
<b>Fuser Cleaning</b>			
FA5-1952-000	15009369 	<b>Oil Roller FIBRA™</b> Enhanced fuser cleaning efficiency.	NP 1015, NP 1215, NP 1318, NP 1510, NP 1520, NP 1530, NP 1550, NP 2010, NP 6116, NP 6216, NP 6317, NP 6318
FA5-1952-000	15632356 	<b>Oil Roller</b>	NP 1015, NP 1215, NP 1318, NP 1510, NP 1520, NP 1530, NP 1550, NP 2010, NP 6116, NP 6216, NP 6317, NP 6318
FC2-2261-000	15021708 	<b>Oil Roller FIBRA™</b>	NP 1015, NP 1215, NP 1318, NP 1510, NP 1520, NP 1530, NP 1550, NP 2010, NP 6116, NP 6216, NP 6318
FC2-2261-000	15009369 	<b>Oil Roller FIBRA™</b> Enhanced fuser cleaning efficiency.	NP 1015, NP 1215, NP 1318, NP 1510, NP 1520, NP 1530, NP 1550, NP 2010, NP 6116, NP 6216, NP 6318
FC2-2261-000	15632356 	<b>Oil Roller</b>	NP 1015, NP 1215, NP 1318, NP 1510, NP 1520, NP 1530, NP 1550, NP 2010, NP 6116, NP 6216, NP 6318
FA6-5369-000	15010507 	<b>Oil Roller FIBRA™</b> Enhanced fuser cleaning efficiency.	NP 2020, NP 2120, NP 3020, NP 6020, NP 6220, NP 6221
FA6-5369-000	15021709 	<b>Oil Roller FIBRA™</b>	NP 2020, NP 2120, NP 3020, NP 6020, NP 6220, NP 6221
FA6-5369-000	15632302 	<b>Oil Roller</b>	NP 2020, NP 2120, NP 3020, NP 6020, NP 6220, NP 6221
FC2-2262-000	15010507 	<b>Oil Roller FIBRA™</b> Enhanced fuser cleaning efficiency.	NP 2020, NP 2120, NP 3020, NP 6020, NP 6220, NP 6221
FC2-2262-000	15021709 	<b>Oil Roller FIBRA™</b>	NP 2020, NP 2120, NP 3020, NP 6020, NP 6220, NP 6221
FC2-2262-000	15632302 	<b>Oil Roller</b>	NP 2020, NP 2120, NP 3020, NP 6020, NP 6220, NP 6221
FF2-0175-020 <i>Final Inventory</i>	15012046 	<b>Fuser Roller Cleaning Felt Assembly</b>	NP 3030, NP 3050, NP 3325, NP 3825, NP 3825 II, NP 4050, NP 4080, NP 4335, NP 4835, NP 4835 i, NP 6241, NP 6825 DADF, NP 6826 DADF, NP 6831, NP 6835 RDF
FA5-3720-000	15632388 	<b>Web Supply Roller</b>	NP 5020, NP 5060, NP 6060, NP 6062, NP 6085, NP 6150, NP 6285, NP 6650, NP 6850, NP 6880, NP 6885, NP 8530, NP 8580, NP 9085, NP 9800
FY1-1045-000	15632388 	<b>Web Supply Roller</b>	NP 5020, NP 5060, NP 6060, NP 6062, NP 6085, NP 6150, NP 6285, NP 6650, NP 6850, NP 6880, NP 6885, NP 8530, NP 8580, NP 9085, NP 9800
FF1-6756-020 <i>Final Inventory</i>	15142551 	<b>Thermistor Cleaning Felt</b>	NP 5020, NP 5060, NP 6150, NP 6650, NP 6850, NP 6880, NP 6885, NP 7050, NP 7550, NP 8070, NP 8530, NP 8570, NP 8580, NP 9800





For use in  
**Canon**  
 Copiers

**Central/Eastern Europe**  
 Telephone: 31(0)183-696969  
 Fax: 31(0)183-629055  
 E-mail: order@edc.katun.com

OEM PN	KATUN PN	DESCRIPTION	MODEL NO.
-----------	-------------	-------------	--------------

## Fuser Cleaning

FC1-5570-000 <i>Final Inventory</i>	15016372 	<b>Fuser Oil Pad</b>	NP 6060, NP 6062
1138908-000	15636505 	<b>Web Supply Roller</b> Universal	NP 6330
8-DS004-01	15636505 	<b>Web Supply Roller</b> Universal	NP 9030, NP 9330



Central/Eastern Europe  
Telephone: 31(0)183-696969  
Fax: 31(0)183-629055  
E-mail: order@edc.katun.com









For use in  
**Canon**  
Copiers

OEM PN	KATUN PN	DESCRIPTION	MODEL NO.
<b>Fuser Oil</b>			
FG5-3918-050	15019687 	<b>Silicone Fuser Oil</b> 1000 ml / Bottle	CLC 700, CLC 700 E, CLC 700 L, CLC 700 S, CLC 800, CLC 800 S, CLC 900, CLC 920, CLC 950, CLC 1000, CLC 1000 S, CLC 1100, CLC 1130, CLC 1150, CLC 3100, CLC 3900, CLC 4000, CLC 5000, CLC 5100







*Priced per Bottle,  
sold in Boxes of 6.*

For use in  
**Canon**  
 Copiers

**Central/Eastern Europe**  
 Telephone: 31(0)183-696969  
 Fax: 31(0)183-629055  
 E-mail: order@edc.katun.com





OEM PN	KATUN PN	DESCRIPTION	MODEL NO.
<b>Gears</b>			
N/P/N	15022504 	<b>Stapler Drive Gear</b> Repairs OEM PN: FC1-9632-000	GP 30 F, GP 55, GP 55 F, GP 55 II, GP 555, NP 2020, NP 2120, NP 3030, NP 3050, NP 6016, NP 6025, NP 6028, NP 6030, NP 6045, NP 6221, NP 6251, NP 6330, NP 6521, NP 6831, FINISHER- D1
FS6-0708-000	15022503 	<b>Pickup Roller Drive Gear</b> Replaces OEM plastic gear	GP 210, GP 215, GP 220, GP 225
N/P/N	15020919 	<b>Fuser Gear Set</b> Gear Set Includes: FS2-0888-020 (1) FS2-0890-020 (1) FS2-0891-020 (1)	NP 1215, NP 1318, NP 1520, NP 6318
			<i>Priced per Set, 3 Gears per Set.</i>
N/P/N	15022502 	<b>Step motor gear-E1 Sorter</b> Repairs OEM PN: FH7-1935-000 & FH7-1848-000	NP 6028, NP 6035, NP 6035 F, NP 6050, NP 6050 ER, NP 6085, NP 6251
FS6-0099-000	15017256 	<b>Drive Gear</b>	NP 6045, NP 6050, NP 6050 ER
FS4-0366-000	15022501 	<b>Brass one-way gear</b> Replaces OEM plastic gear	NP 6050, NP 6050 ER, NP 6085, NP 6285
FS3-0204-000	15016762 	<b>Original Feed Roller Gear (29T)</b>	RDF- 2, RDF- 2 N, RDF- 3, RDF- A1
FS4-0051-000	15017949 	<b>Original Feed Roller Gear (22T)</b>	RDF- B1, RDF- C1, RF- B1



OEM PN	KATUN PN	DESCRIPTION	MODEL NO.
<b>Kits</b>			
N/P/N	15012619 	<b>Feed Tire Replacement Kit</b> Tire Only  Kit Contains: • (4) Paper Feed Tire • (4) Paper Pickup Tire • (4) Separation Tire	CLC 700, CLC 700 E, CLC 700 L, CLC 700 S, CLC 800, CLC 800 S, GP 30 F, GP 55, GP 55 F, GP 55 II, NP 6025, NP 6028, NP 6030, NP 6035, NP 6035 F, CFU- F1, CFU- G1, CFU- H1, DU- A1
N/P/N	15015694 	<b>Upper Fuser Roller Bearing Kit</b> Kit Contains: • (2) Upper Heat Insulating Sleeve • (2) Upper Fuser Roller Bearing	GP 30 F, GP 55, GP 55 F, GP 55 II, NP 6025, NP 6028, NP 6030, NP 6035, NP 6035 F, NP 6330
N/P/N	15018540 	<b>OPC Drum Kit</b> Kit Contains: • (1) OPC Drum • (1) Drum Cleaning Blade 20 OPC Kits per Master Carton	GP 210, GP 215, GP 220, GP 225
			<i>Priced per OPC Kit, sold per OPC Kit.</i>
N/P/N	15021849 	<b>Feed Tire Replacement Kit</b> Tire Only  Kit Contains: • (4) Paper Feed Tire • (2) Separation Tire	GP 210, GP 215, GP 220, GP 225, GP 285, GP 335, GP 405, iR 400, iR 2200, iR 2800, iR 3300, iR C 2100, iR C 2100 S, iR C 2105, CFU- L1, CFU- M1, CFU- R1, CFU- S1, CFU- U1, CFU- W1
N/P/N	15019840 	<b>OPC Drum Kit</b> Kit Contains: • (1) OPC Drum • (1) Drum Cleaning Blade 12 OPC Kits per Master Carton	GP 285, GP 335, GP 405, iR 400
			<i>Priced per OPC Kit, sold per OPC Kit.</i>
N/P/N	15021762 	<b>Feed Tire Replacement Kit</b> For DeckimageRUNNER 330/400 For Deck/CassetteimageRUNNER 550/600 Kit Contains: • (2) Paper Pickup Tire • (2) Paper Feed Tire • (1) Separation Roller	GP 335, GP 405, GP 555, GP 605, iR 85, iR 400, iR 7200, iR 8500, PD- F1, PD- L1
F02-5301-000	15020772 	<b>250K Maintenance Kit</b> Kit Contains: • (3) Drum Picker Finger • (4) Corona Wire Cleaner • (10) Paper Pickup/Feed Roller • (10) Paper Pickup Roller • (4) Separation Roller • (1) Sponge Roller	GP 555, GP 605

For use in  
**Canon**  
 Copiers

**Central/Eastern Europe**  
 Telephone: 31(0)183-696969  
 Fax: 31(0)183-629055  
 E-mail: order@edc.katun.com





OEM PN	KATUN PN	DESCRIPTION	MODEL NO.
<b>Kits</b>			
F02-5302-020	15021634 	<b>500K Maintenance Kit</b> Kit Contains: <ul style="list-style-type: none"> <li>• (2) Upper Heat Insulating Sleeve</li> <li>• (1) Upper Fuser Roller</li> <li>• (3) Drum Picker Finger</li> <li>• (6) Upper Picker Finger</li> <li>• (8) Corona Wire Cleaner</li> <li>• (1) Thermistor</li> <li>• (1) Thermistor 2</li> <li>• (10) Paper Pickup/Feed Roller</li> <li>• (10) Paper Pickup Roller</li> <li>• (1) Web Supply Roller</li> <li>• (1) Pretransfer Scraper Blade</li> <li>• (1) Sponge Roller</li> <li>• (1) Lower Pressure Roller</li> <li>• (4) Separation Roller</li> <li>• (3) Decurling Guide</li> </ul>	GP 555, GP 605
F02-5303-000	15021207 	<b>ADF Maintenance Kit</b> Kit Contains: <ul style="list-style-type: none"> <li>• (1) Original Document Feed Belt</li> <li>• (12) Separation Belt</li> <li>• (12) ADF Feed Roller Assembly</li> <li>• (2) Pickup Roller</li> </ul>	GP 555, GP 605
N/P/N	15023391 	<b>OPC Drum Kit</b> Kit Contains: <ul style="list-style-type: none"> <li>• (1) OPC Drum</li> <li>• (1) Drum Cleaning Blade</li> </ul> 12 OPC Kits per Master Carton	iR 1210, iR 1230, iR 1270 F
N/P/N	15022942 	<b>OPC Drum Kit</b> Kit Contains: <ul style="list-style-type: none"> <li>• (1) OPC Drum</li> <li>• (1) Drum Cleaning Blade</li> </ul> 12 OPC Kits per Master Carton	iR 2200, iR 2800, iR 3300, iR 3300 i
N/P/N	15011634 	<b>OPC Drum Kit</b> Kit Contains: <ul style="list-style-type: none"> <li>• (1) OPC Drum</li> <li>• (1) Drum Cleaning Blade</li> <li>• (1) Corona Wire</li> <li>• (1) Corona Wire Spring</li> <li>• (3) Screw</li> </ul> 12 OPC Kits per Master Carton	NP 1010, NP 1020, NP 6010

*Priced per OPC Kit,  
 sold per OPC Kit.*

*Priced per OPC Kit,  
 sold per OPC Kit.*

*Priced per OPC Kit,  
 sold per OPC Kit.*









OEM PN	KATUN PN	DESCRIPTION	MODEL NO.	
<b>Kits</b>				
N/P/N	15015485	<b>OPC Drum Kit Access By Katun</b>	NP 1015, NP 1215, NP 1318, NP 1510, NP 1520, NP 1530, NP 1550, NP 2010, NP 2020, NP 2120, NP 6020, NP 6116, NP 6216, NP 6220, NP 6221, NP 6317, NP 6318	<i>Priced per OPC Kit, sold per OPC Kit.</i>
		Kit Contains:		
		• (1) Drum Cartridge Seal Tape		
		• (1) Drum Cleaning Blade		
		• (1) OPC Drum		
		12 OPC Kits per Master Carton		
N/P/N	15014438 	<b>OPC Drum Kit</b>	NP 1015, NP 1215, NP 1318, NP 1510, NP 1520, NP 2010, NP 6318	<i>Priced per OPC Kit, sold per OPC Kit.</i>
		Kit Contains:		
		• (1) OPC Drum		
		• (1) Drum Cleaning Blade		
		• (1) Upper Drum Unit Seal		
		12 OPC Kits per Master Carton		
N/P/N	15014101 	<b>Fuser Assembly Convenience Kit</b>	NP 1015, NP 1215, NP 1510, NP 1520, NP 1530, NP 1550, NP 2010, NP 6116, NP 6216, NP 6318	
		Kit Contains:		
		• (1) Upper Fuser Roller		
		• (2) Upper Fuser Roller Bushing		
		• (1) Lower Pressure Roller		
		• (1) Oil Roller		
		• (5) Lower Picker Finger		
		• (5) Upper Picker Finger		
N/P/N	15019619 	<b>Fuser Assembly Convenience Kit</b>	NP 1015, NP 1215, NP 1510, NP 1520, NP 1530, NP 1550, NP 2010, NP 6116, NP 6216, NP 6318	
		Includes OEM Type (Blue) Roller		
		Kit Contains:		
		• (1) Lower Pressure Roller		
		• (5) Upper Picker Finger		
		• (1) Upper Fuser Roller		
		• (5) Lower Picker Finger		
		• (2) Upper Fuser Roller Bushing		
		• (1) Oil Roller		
N/P/N	15014440 	<b>OPC Drum Kit</b>	NP 1530, NP 1550, NP 2020, NP 2120, NP 6020, NP 6116, NP 6216, NP 6220, NP 6221, NP 6317	<i>Priced per OPC Kit, sold per OPC Kit.</i>
		Kit Contains:		
		• (1) OPC Drum		
		• (1) Drum Cleaning Blade		
		• (1) Upper Drum Unit Seal		
		12 OPC Kits per Master Carton		
N/P/N	15015697 	<b>Upper Fuser Roller Bearing Kit</b>	NP 2020, NP 2120, NP 3020, NP 3030, NP 3050, NP 3325, NP 3825, NP 3825 II, NP 4050, NP 4080, NP 4335, NP 4835, NP 4835 i, NP 6220, NP 6221, NP 6241, NP 6825 DADF, NP 6826 DADF, NP 6831, NP 6835 RDF	
		Kit Contains:		
		• (2) Heat Insulating Sleeve		
		• (2) Upper Fuser Roller Bearing		









For use in  
**Canon**  
 Copiers

**Central/Eastern Europe**  
 Telephone: 31(0)183-696969  
 Fax: 31(0)183-629055  
 E-mail: order@edc.katun.com







OEM PN	KATUN PN	DESCRIPTION	MODEL NO.
<b>Kits</b>			
N/P/N	15009307 	<b>OPC Drum Kit</b> Kit Contains: • (1) OPC Drum • (1) Drum Cleaning Blade 12 OPC Kits per Master Carton	NP 3030, NP 3050, NP 6831  <i>Priced per OPC Kit, sold per OPC Kit.</i>
N/P/N	15502791 	<b>OPC Drum Kit</b> Kit Contains: • (1) OPC Drum • (1) Drum Cleaning Blade 12 OPC Kits per Master Carton	NP 3325, NP 3825, NP 3825 II, NP 6825 DADF, NP 6826 DADF  <i>Priced per OPC Kit, sold per OPC Kit.</i>
N/P/N	15015696 	<b>Upper Fuser Roller Bearing Kit</b> Kit Contains: • (1) Heat Insulating Sleeve • (1) Heat Insulating Sleeve • (2) Upper Fuser Roller Bearing	NP 4040, NP 4540, NP 5020, NP 5060, NP 6150, NP 6650, NP 6850
N/P/N	15012618 	<b>Feed Tire Replacement Kit</b> Tire Only Kit Contains: • (4) Paper Feed Tire • (4) Paper Pickup Tire • (4) Separation Tire	NP 4050, NP 4080, NP 4335, NP 4835, NP 4835 i, NP 6241, NP 6835 RDF, CFU- D1
N/P/N	15009319 	<b>OPC Drum Kit</b> Kit Contains: • (1) OPC Drum • (1) Drum Cleaning Blade • (1) Precut Corona Wire 12 OPC Kits per Master Carton	NP 4050, NP 4080, NP 6241  <i>Priced per OPC Kit, sold per OPC Kit.</i>
N/P/N	15009317 	<b>OPC Drum Kit</b> Kit Contains: • (1) OPC Drum • (1) Drum Cleaning Blade • (1) Precut Corona Wire 12 OPC Kits per Master Carton	NP 4335, NP 4835, NP 4835 i, NP 6835 RDF  <i>Priced per OPC Kit, sold per OPC Kit.</i>
N/P/N	15022522 	<b>OPC Drum Kit</b> Kit Contains: • (1) OPC Drum • (1) Drum Cleaning Blade • (1) Toner Recovery Seal 1 OPC Kit per Master Carton	NP 6012, NP 6112, NP 6212, NP 6312, NP 6612, NP 7130 F  <i>Priced per OPC Kit, sold per OPC Kit.</i>







OEM PN	KATUN PN	DESCRIPTION	MODEL NO.
<b>Kits</b>			
N/P/N	15022733 	<b>OPC Drum Kit</b> Kit Contains: • (1) OPC Drum • (1) Drum Cleaning Blade • (1) Cleaning Blade Seal Tape 24 OPC Kits per Master Carton	NP 6016, NP 6218, NP 6521, NP 6621  <i>Priced per OPC Kit, sold per OPC Kit.</i>
N/P/N	15014355 	<b>OPC Drum Kit</b> Kit Contains: • (1) OPC Drum • (1) Drum Cleaning Blade • (1) Cleaning Blade Seal Tape 1 OPC Kit per Master Carton	NP 6025, NP 6030  <i>Priced per OPC Kit, sold per OPC Kit.</i>
N/P/N	15021699 	<b>Door Paper Guide Kit</b> Alternative to replacing entire door. Kit Contains: • (5) Door Paper Guide • (1) Cyanolube Adhesive • (1) Rebuild Instructions	NP 6025, NP 6030
N/P/N	15021706 	<b>Feed Tire Replacement Kit</b> Kit Contains: • (2) Paper Feed Tire • (2) Paper Pickup Tire • (1) Separation Roller	NP 6045, NP 6050, NP 6050 ER, NP 6251, NP 6260, NP 6350, NP 6360, NP 7500, PDP- A1
N/P/N	15015693 	<b>Upper Fuser Roller Bearing Kit</b> Kit Contains: • (2) Upper Heat Insulating Sleeve • (2) Upper Fuser Roller Bearing	NP 6045, NP 6050, NP 6050 ER, NP 6251, NP 6350, NP 7500
F02-1005-030	15018576 	<b>500K Maintenance Kit</b> Includes TUF/SIL Upper Fuser Roller Kit Contains: • (1) Pretransfer Scraper Blade • (1) Thermistor • (2) Upper Heat Insulating Sleeve • (1) Lower Pressure Roller • (1) Upper Fuser Roller TUF/SIL™ • (6) Upper Picker Finger • (2) Corona Wire Cleaner • (2) Corona Wire Cleaner • (4) Corona Wire Cleaner • (2) Bearing	NP 6050, NP 6050 ER

For use in  
**Canon**  
 Copiers















**Central/Eastern Europe**  
 Telephone: 31(0)183-696969  
 Fax: 31(0)183-629055  
 E-mail: order@edc.katun.com





OEM PN	KATUN PN	DESCRIPTION	MODEL NO.
<b>Kits</b>			
F02-1005-030	15016685 	<b>500K Maintenance Kit</b> Includes Triton II Upper Fuser Roller Kit Contains: <ul style="list-style-type: none"> <li>• (1) Pretransfer Scraper Blade</li> <li>• (6) Upper Picker Finger</li> <li>• (1) Upper Fuser Roller TRITON™ II</li> <li>• (1) Lower Pressure Roller</li> <li>• (2) Upper Heat Insulating Sleeve</li> <li>• (2) Bearing</li> <li>• (8) Corona Wire Cleaner</li> <li>• (1) Thermistor</li> </ul>	NP 6050, NP 6050 ER
N/P/N	15021488 	<b>Front Tray Feed Tire Replacement Kit</b> with Sponge Rollers Kit Contains: <ul style="list-style-type: none"> <li>• (4) Paper Pickup Tire</li> <li>• (4) Paper Feed Tire</li> <li>• (2) Separation Roller</li> </ul>	NP 6060, NP 6062
N/P/N	15021489 	<b>Side Tray Feed Tire Replacement Kit</b> Kit Contains: <ul style="list-style-type: none"> <li>• (2) Paper Pickup Tire</li> <li>• (2) Paper Feed Tire</li> <li>• (1) Separation Roller</li> </ul>	NP 6060, NP 6062
N/P/N	15014798 	<b>Document Feeder Replacement Kit</b> Kit Contains: <ul style="list-style-type: none"> <li>• (2) Paper Pickup Tire</li> <li>• (9) Original Feed Tire</li> <li>• (6) Separation Belt</li> </ul>	ADF- A1
N/P/N	15012653 	<b>Feed Tire Replacement Kit</b> Tire Only Kit Contains: <ul style="list-style-type: none"> <li>• (2) Paper Feed Tire</li> <li>• (2) Paper Pickup Tire</li> <li>• (2) Separation Tire</li> </ul>	PD- 5
N/P/N	15012313 	<b>Paper Feed Tire Kit</b> Kit Contains: <ul style="list-style-type: none"> <li>• (2) Paper Feed Tire</li> <li>• (2) Separation Tire</li> <li>• (2) Paper Pickup Tire</li> </ul>	PD- 8, PDP- C1, PDP- D1, PDP- E1
N/P/N	15017473 	<b>RDF Rebuild Kit</b> Kit Contains: <ul style="list-style-type: none"> <li>• (1) Original Feed Roller Unit</li> <li>• (6) Paper Feed Belt</li> <li>• (2) Original Pickup Roller</li> <li>• (1) Original Feed Roller Gear (29T)</li> </ul>	RDF- 2, RDF- 2 N, RDF- 3, RDF- A1

OEM PN	KATUN PN	DESCRIPTION	MODEL NO.
<b>Kits</b>			
N/P/N	15011753 	<b>Document Feeder Replacement Kit</b> Kit Contains: <ul style="list-style-type: none"> <li>• (6) Separation Belt</li> <li>• (4) Reverse Tire</li> <li>• (9) Original Feed Tire</li> <li>• (2) Original Pickup Roller</li> </ul>	RDF- 2, RDF- 3, RDF- A1
N/P/N	15012139 	<b>Document Feeder Replacement Kit</b> Kit Contains: <ul style="list-style-type: none"> <li>• (9) Original Feed Tire</li> <li>• (2) Original Pickup Roller</li> <li>• (6) Separation Belt</li> </ul>	RDF- 2, RDF- 3, RDF- A1
N/P/N	15018575 	<b>RDF Rebuild Kit</b> Kit Contains: <ul style="list-style-type: none"> <li>• (1) Original Feed Roller</li> <li>• (9) Separation Belt</li> <li>• (1) Original Feed Roller Gear (22T)</li> <li>• (2) Paper Pickup Roller</li> </ul>	RDF- B1, RDF- C1
N/P/N	15012976 	<b>Document Feeder Replacement Kit</b> Kit Contains: <ul style="list-style-type: none"> <li>• (9) Separation Belt</li> <li>• (12) Original Feed Tire</li> <li>• (2) Original Pickup Roller</li> </ul>	RDF- B1, RDF- C1, RDF- F1
N/P/N	15018277 	<b>250K Maintenance Kit</b> Kit Contains: <ul style="list-style-type: none"> <li>• (22) Separation Tire</li> <li>• (1) Original Document Feed Belt</li> <li>• (17) Separation Belt</li> <li>• (4) Paper Pickup Roller</li> <li>• (2) Separation Flapper</li> <li>• (3) Separation Flapper</li> </ul>	RDF- D1, RDF- E1

For use in  
**Canon**  
 Copiers

**Central/Eastern Europe**  
 Telephone: 31(0)183-696969  
 Fax: 31(0)183-629055  
 E-mail: order@edc.katun.com



OEM PN	KATUN PN	DESCRIPTION	MODEL NO.
<b>Lamps</b>			
FH7-4272-000	15021106 	<b>Heater Lamp</b> 220V 400W	CLC 200, CLC 300, CLC 320, CLC 350, CLC 500, CLC 550
FH7-4594-000	15023103 	<b>Heater Lamp</b> 230V 910W	GP 555, GP 605
FH7-4602-000	15022292 	<b>Heater Lamp</b> 230V 390W	GP 555, GP 605
FH7-3105-000	15021199 	<b>Exposure Lamp</b> 150V 230W	NP 1010, NP 1020, NP 6010, PC 6, PC 7, PC 8, PC 11
FH7-4231-000	15021576 	<b>Heater Lamp</b> 220V 850W	NP 1010, NP 1020, NP 6010, PC 6, PC 7, PC 8, PC 11
FH7-4239-020	15021080 	<b>Heater Lamp</b> 220V 900W	NP 1015, NP 1215, NP 1318, NP 1510, NP 1520, NP 1530, NP 1550, NP 2010, NP 6116, NP 6216, NP 6318
FH7-4239-020	15017046	<b>Heater Lamp</b> <b>Access By Katun</b> 220V 900W	NP 1015, NP 1215, NP 1318, NP 1510, NP 1520, NP 1530, NP 1550, NP 2010, NP 6116, NP 6216, NP 6318
FH7-3114-000	15021135 	<b>Exposure Lamp</b> 175V 330W	NP 1015, NP 1215, NP 1510, NP 1520, NP 1530, NP 1550, NP 2020, NP 2120, NP 3020, NP 3030, NP 3050, NP 3325, NP 3825, NP 3825 II, NP 6020, NP 6116, NP 6216, NP 6220, NP 6221, NP 6317, NP 6318, NP 6320, NP 6825 DADF, NP 6826 DADF, NP 6831
FH7-3114-000	15017048	<b>Exposure Lamp</b> <b>Access By Katun</b> 175V 330W	NP 1015, NP 1215, NP 1510, NP 1520, NP 1530, NP 1550, NP 2020, NP 2120, NP 3020, NP 3030, NP 3050, NP 3325, NP 3825, NP 3825 II, NP 6020, NP 6116, NP 6216, NP 6220, NP 6221, NP 6317, NP 6318, NP 6320, NP 6825 DADF, NP 6826 DADF, NP 6831
FH7-3247-000	15021136 	<b>Exposure Lamp</b> 175V 300W	NP 4050, NP 4080, NP 6241
FH7-3153-020	15021136 	<b>Exposure Lamp</b> 175V 300W	NP 4335, NP 4835, NP 4835 i, NP 6835 RDF
FH7-3161-000	15021202 	<b>Exposure Lamp</b> 175V 280W	NP 5020, NP 5060, NP 6150, NP 6650, NP 6850
FH7-4360-000	15021077 	<b>Sub Heater Lamp</b> 230V 640W	NP 6025, NP 6028, NP 6030, NP 6035, NP 6035 F
FH7-3321-000	15021452 	<b>Exposure Lamp</b> 175V 340W	NP 6028, NP 6035, NP 6035 F, NP 6330
FH7-3216-000	15021140 	<b>Exposure Lamp</b> 146V 210W	NP 6060, NP 6062
FH7-3288-000	15021162 	<b>Exposure Lamp</b> 175V 330W	NP 6085, NP 6285, NP 9085
FH7-4088-040	15021110 	<b>Heater Lamp</b> 220V 1100W	PC 10, PC 14, PC 20, PC 22

OEM PN	KATUN PN	DESCRIPTION	MODEL NO.
<b>Memory Upgrades</b>			
FGP-04001000 <i>Final Inventory</i>	15017645 	<b>Memory Upgrade Board- 8 MB</b> Printer Controller Memory	GP 30 F, GP 55, GP 55 F, GP 55 II, GP 210, GP 215, GP 220, GP 225
FGP-04002000 <i>Final Inventory</i>	15017648 	<b>Memory Upgrade Board- 16 MB</b> Printer Controller Memory	GP 30 F, GP 55, GP 55 F, GP 55 II, GP 210, GP 215, GP 220, GP 225
FGP-5632-000 <i>Final Inventory</i>	15017645 	<b>Memory Upgrade Board- 8 MB</b> Printer Controller Memory	GP 30 F, GP 55, GP 55 F, GP 55 II, GP 210, GP 215, GP 220, GP 225
N/P/N <i>Final Inventory</i>	15017634 	<b>Memory Upgrade Board- 32 MB</b> Printer Memory Upgrade	GP 335, GP 405, GP 555, GP 605, iR 400











For current memory upgrade pricing, visit our on-line catalogue at [www.katun.com](http://www.katun.com) or contact your customer service representative.

For use in  
**Canon**  
 Copiers

**Central/Eastern Europe**  
 Telephone: 31(0)183-696969  
 Fax: 31(0)183-629055  
 E-mail: order@edc.katun.com

OEM PN	KATUN PN	DESCRIPTION	MODEL NO.
<b>Miscellaneous</b>			
C4214-60103 <i>Final Inventory</i>	15019369	<b>User Guide Original</b>	iR 3250
C4214-99021 <i>Final Inventory</i>	15019371	<b>Service Manual Original</b>	iR 3250
RB1-6625-000	15019529 	<b>Fuser Assembly Cover</b>	iR 3250
N/P/N	15021529 	<b>Main Drive Repair Kit (carrousel gear)</b> Repairs OEM PN: FG9-0998-000	NP 2020, NP 2120, NP 6221
N/P/N	15022661 	<b>E1/E2 sorter repair kit</b> Repairs: E1 & E2 Finishers	NP 6028, NP 6035, NP 6035 F, NP 6045, NP 6050, NP 6050 ER, NP 6085, NP 6251, SORTER- E1, SORTER- E2



OEM PN	KATUN PN	DESCRIPTION	MODEL NO.
<b>Photoreceptors</b>			
1352A001AA	15013775	<b>OPC Drum Original</b>	CLC 200, CLC 300, CLC 320, CLC 350
F43-4601-000	15017694	<b>OPC Drum Original</b>	CLC 700, CLC 700 E, CLC 700 L, CLC 700 S, CLC 800, CLC 800 S, CLC 900, CLC 920, CLC 950, CLC 1130, CLC 1150
N/P/N	15010710 	<b>OPC Drum</b>  20 Drums per Master Carton	FC 1, FC 2, FC 3, FC 3 II, FC 5, FC 5 II, FC 22, PC 6, PC 7, PC 7 RE, PC 8, PC 11
N/P/N	15012792 	<b>OPC Drum</b> Bulk Packaging 1 Box (20 Drums) per Master Carton	FC 210, FC 230, FC 310, FC 325, FC 330, FC 336, PC 720, PC 740, PC 750, PC 780
1340A002AA	15012281 	<b>OPC Drum Unit</b>	GP 30 F, GP 55, GP 55 F, GP 55 II
N/P/N	15014948 	<b>OPC Drum</b> 20 Drums per Master Carton	GP 30 F, GP 55, GP 55 F, GP 55 II
1341A002AA	15014537 	<b>OPC Drum Unit</b>	GP 210, GP 215, GP 220, GP 225
N/P/N	15018540 	<b>OPC Drum Kit</b> Kit Contains: • (1) OPC Drum • (1) Drum Cleaning Blade 20 OPC Kits per Master Carton	GP 210, GP 215, GP 220, GP 225
1342A002AA	15017236 	<b>Drum Unit</b>	GP 285, GP 335, GP 405, iR 400
N/P/N	15019840 	<b>OPC Drum Kit</b> Kit Contains: • (1) OPC Drum • (1) Drum Cleaning Blade 12 OPC Kits per Master Carton	GP 285, GP 335, GP 405, iR 400
N/P/N	15023391 	<b>OPC Drum Kit</b> Kit Contains: • (1) OPC Drum • (1) Drum Cleaning Blade 12 OPC Kits per Master Carton	iR 1210, iR 1230, iR 1270 F
7815A004AB	15023391 	<b>OPC Drum Unit</b> Kit Contains: • (1) OPC Drum • (1) Drum Cleaning Blade 12 OPC Kits per Master Carton	iR 1210, iR 1230, iR 1270 F, IR 1630, IR 1670 F
6837A004AA	15023084	<b>OPC Drum Unit Original</b>	iR 1600, iR 2000, iR 2010 F
6648A003AA	15021540 	<b>OPC Drum Unit</b>	iR 2200, iR 2800, iR 3300, iR 3300 i

*Priced per Drum, sold per Drum.*

*Priced per Drum, sold in Boxes of 20.*

*Priced per Drum, sold per Drum.*

*Priced per OPC Kit, sold per OPC Kit.*





*Priced per OPC Kit, sold per OPC Kit.*

*Priced per OPC Kit, sold per OPC Kit.*

*Priced per OPC Kit, sold per OPC Kit.*

For use in  
**Canon**  
 Copiers











**Central/Eastern Europe**  
 Telephone: 31(0)183-696969  
 Fax: 31(0)183-629055  
 E-mail: order@edc.katun.com

OEM PN	KATUN PN	DESCRIPTION	MODEL NO.
<b>Photoreceptors</b>			
6648A003AA	15023082	<b>OPC Drum Unit Original</b>	iR 2200, iR 2800, iR 3300, iR 3300 i
N/P/N	15022942 	<b>OPC Drum Kit</b> Kit Contains: • (1) OPC Drum • (1) Drum Cleaning Blade 12 OPC Kits per Master Carton	iR 2200, iR 2800, iR 3300, iR 3300 i  <i>Priced per OPC Kit, sold per OPC Kit.</i>
1315A001AA	15000946 	<b>OPC Drum Unit</b>	NP 1010, NP 1020, NP 6010
N/P/N	15011634 	<b>OPC Drum Kit</b> Kit Contains: • (1) OPC Drum • (1) Drum Cleaning Blade • (1) Corona Wire • (1) Corona Wire Spring • (3) Screw 12 OPC Kits per Master Carton	NP 1010, NP 1020, NP 6010  <i>Priced per OPC Kit, sold per OPC Kit.</i>
N/P/N	15000449 	<b>OPC Drum</b> 20 Drums per Master Carton	NP 1010, NP 1020, NP 6010  <i>Priced per Drum, sold per Drum.</i>
N/P/N	15018664 	<b>OPC Drum</b> Adverse Usage Condition Drum  50 Drums per Master Carton	NP 1015, NP 1215, NP 1318, NP 1510, NP 1520, NP 1530, NP 1550, NP 2010, NP 2020, NP 2120, NP 6020, NP 6116, NP 6216, NP 6220, NP 6221, NP 6317, NP 6318  <i>Priced per Drum, sold per Drum.</i>
N/P/N	15015485	<b>OPC Drum Kit Access By Katun</b>  Kit Contains: • (1) Drum Cartridge Seal Tape • (1) Drum Cleaning Blade • (1) OPC Drum 12 OPC Kits per Master Carton	NP 1015, NP 1215, NP 1318, NP 1510, NP 1520, NP 1530, NP 1550, NP 2010, NP 2020, NP 2120, NP 6020, NP 6116, NP 6216, NP 6220, NP 6221, NP 6317, NP 6318  <i>Priced per OPC Kit, sold per OPC Kit.</i>
N/P/N	15015700	<b>OPC Drum Access By Katun</b>  20 Drums per Master Carton	NP 1015, NP 1215, NP 1318, NP 1510, NP 1520, NP 1530, NP 1550, NP 2010, NP 2020, NP 2120, NP 6020, NP 6116, NP 6216, NP 6220, NP 6221, NP 6317, NP 6318  <i>Priced per Drum, sold per Drum.</i>
N/P/N	15015548	<b>OPC Drum Access By Katun</b> Bubble Wrapped Individually 1 Box (20 Drums) per Master Carton	NP 1015, NP 1215, NP 1318, NP 1510, NP 1520, NP 1530, NP 1550, NP 2010, NP 2020, NP 2120, NP 6020, NP 6116, NP 6216, NP 6220, NP 6221, NP 6317, NP 6318  <i>Priced per Drum, sold in Boxes of 20.</i>
1316A001AA	15017692	<b>OPC Drum Unit Original</b>	NP 1015, NP 1215, NP 1318, NP 1510, NP 1520, NP 2010, NP 6318



Katun Performance Product











© 2004 Katun Corporation

OEM PN	KATUN PN	DESCRIPTION	MODEL NO.	
<b>Photoreceptors</b>				
N/P/N	15014438 	<b>OPC Drum Kit</b> Kit Contains: • (1) OPC Drum • (1) Drum Cleaning Blade • (1) Upper Drum Unit Seal 12 OPC Kits per Master Carton	NP 1015, NP 1215, NP 1318, NP 1510, NP 1520, NP 2010, NP 6318	<i>Priced per OPC Kit, sold per OPC Kit.</i>
N/P/N	15014353 	<b>OPC Drum</b> 20 Drums per Master Carton	NP 1015, NP 1215, NP 1318, NP 1510, NP 1520, NP 2010, NP 6318	<i>Priced per Drum, sold per Drum.</i>
N/P/N	15014440 	<b>OPC Drum Kit</b> Kit Contains: • (1) OPC Drum • (1) Drum Cleaning Blade • (1) Upper Drum Unit Seal 12 OPC Kits per Master Carton	NP 1530, NP 1550, NP 2020, NP 2120, NP 6020, NP 6116, NP 6216, NP 6220, NP 6221, NP 6317	<i>Priced per OPC Kit, sold per OPC Kit.</i>
N/P/N	15014366 	<b>OPC Drum</b> 20 Drums per Master Carton	NP 1530, NP 1550, NP 2020, NP 2120, NP 6020, NP 6116, NP 6216, NP 6220, NP 6221, NP 6317	<i>Priced per Drum, sold per Drum.</i>
1331A001AA	15016363 	<b>OPC Drum Unit</b> Adverse Usage Condition Cartridge	NP 1530, NP 1550, NP 2020, NP 2120, NP 6020, NP 6116, NP 6216, NP 6220, NP 6221, NP 6317, NP 6320	
1331A001AA	15017691	<b>OPC Drum Unit</b> <b>Original</b>	NP 1530, NP 1550, NP 2020, NP 2120, NP 6020, NP 6116, NP 6216, NP 6220, NP 6221, NP 6317, NP 6320	
N/P/N	15016665 	<b>OPC Drum</b> 20 Drums per Master Carton	NP 3020	<i>Priced per Drum, sold per Drum.</i>
1318A001AA	15018884 	<b>OPC Drum</b> 12 Drums per Master Carton	NP 3025, NP 3225, NP 3525, NP 3725	<i>Priced per Drum, sold per Drum.</i>
1333A001AA	15020090 	<b>OPC Drum Unit</b>	NP 3030, NP 3050	
1333A004BA	15016511 	<b>OPC Drum</b> 12 Drums per Master Carton	NP 3030, NP 3050, NP 6831	<i>Priced per Drum, sold per Drum.</i>
N/P/N	15009307 	<b>OPC Drum Kit</b> Kit Contains: • (1) OPC Drum • (1) Drum Cleaning Blade 12 OPC Kits per Master Carton	NP 3030, NP 3050, NP 6831	<i>Priced per OPC Kit, sold per OPC Kit.</i>
F43-2011-000	15016512 	<b>OPC Drum</b> 12 Drums per Master Carton	NP 3325, NP 3825, NP 3825 II, NP 6825 DADF, NP 6826 DADF	<i>Priced per Drum, sold per Drum.</i>



For use in  
**Canon**  
 Copiers







**Central/Eastern Europe**  
 Telephone: 31(0)183-696969  
 Fax: 31(0)183-629055  
 E-mail: order@edc.katun.com

OEM PN	KATUN PN	DESCRIPTION	MODEL NO.	
<b>Photoreceptors</b>				
N/P/N	15502791 	<b>OPC Drum Kit</b>  Kit Contains: <ul style="list-style-type: none"> <li>• (1) OPC Drum</li> <li>• (1) Drum Cleaning Blade</li> </ul> 12 OPC Kits per Master Carton	NP 3325, NP 3825, NP 3825 II, NP 6825 DADF, NP 6826 DADF	<i>Priced per OPC Kit, sold per OPC Kit.</i>
1332A001AA	15020089 	<b>OPC Drum Unit</b>	NP 4050, NP 4080, NP 6241	
1332A001AA	15013340	<b>OPC Drum Unit Original</b>	NP 4050, NP 4080, NP 6241	
F43-3101-000	15020089 	<b>OPC Drum Unit</b>	NP 4050, NP 4080, NP 6241	
F43-3111-000	15009318 	<b>OPC Drum</b> 12 Drums per Master Carton	NP 4050, NP 4080, NP 6241	<i>Priced per Drum, sold per Drum.</i>
N/P/N	15009319 	<b>OPC Drum Kit</b>  Kit Contains: <ul style="list-style-type: none"> <li>• (1) OPC Drum</li> <li>• (1) Drum Cleaning Blade</li> <li>• (1) Precut Corona Wire</li> </ul> 12 OPC Kits per Master Carton	NP 4050, NP 4080, NP 6241	<i>Priced per OPC Kit, sold per OPC Kit.</i>
1321A004BA	15009130 	<b>OPC Drum</b> 12 Drums per Master Carton	NP 4335, NP 4835, NP 4835 i, NP 6835 RDF	<i>Priced per Drum, sold per Drum.</i>
N/P/N	15009317 	<b>OPC Drum Kit</b>  Kit Contains: <ul style="list-style-type: none"> <li>• (1) OPC Drum</li> <li>• (1) Drum Cleaning Blade</li> <li>• (1) Precut Corona Wire</li> </ul> 12 OPC Kits per Master Carton	NP 4335, NP 4835, NP 4835 i, NP 6835 RDF	<i>Priced per OPC Kit, sold per OPC Kit.</i>
F43-5401-000	15016498 	<b>OPC Drum Unit</b>	NP 6012, NP 6112, NP 6212, NP 6312, NP 6512, NP 6612	
1337A001AA	15016498 	<b>OPC Drum Unit</b>	NP 6012, NP 6112, NP 6212, NP 6312, NP 6512, NP 6612, NP 7130, NP 7130 F	
N/P/N	15022522 	<b>OPC Drum Kit</b>  Kit Contains: <ul style="list-style-type: none"> <li>• (1) OPC Drum</li> <li>• (1) Drum Cleaning Blade</li> <li>• (1) Toner Recovery Seal</li> </ul> 1 OPC Kit per Master Carton	NP 6012, NP 6112, NP 6212, NP 6312, NP 6612, NP 7130 F	<i>Priced per OPC Kit, sold per OPC Kit.</i>



OEM PN	KATUN PN	DESCRIPTION	MODEL NO.
-----------	-------------	-------------	--------------









## Photoreceptors

N/P/N	15022733 	<b>OPC Drum Kit</b> Kit Contains: • (1) OPC Drum • (1) Drum Cleaning Blade • (1) Cleaning Blade Seal Tape 24 OPC Kits per Master Carton	NP 6016, NP 6218, NP 6521, NP 6621	<i>Priced per OPC Kit, sold per OPC Kit.</i>
1334A002AA	15019721 	<b>OPC Drum Unit</b>	NP 6025, NP 6030	
1334A002AA	15017693	<b>OPC Drum Unit Original</b>	NP 6025, NP 6030	
F43-4011-100	15019721 	<b>OPC Drum Unit</b>	NP 6025, NP 6030	
N/P/N	15014355 	<b>OPC Drum Kit</b> Kit Contains: • (1) OPC Drum • (1) Drum Cleaning Blade • (1) Cleaning Blade Seal Tape 1 OPC Kit per Master Carton	NP 6025, NP 6030	<i>Priced per OPC Kit, sold per OPC Kit.</i>
1338A002AA	15020094 	<b>OPC Drum Unit</b>	NP 6028, NP 6035, NP 6035 F	
F43-5811-100	15020094 	<b>OPC Drum Unit</b>	NP 6028, NP 6035, NP 6035 F	









For use in  
**Canon**  
Copiers

**Central/Eastern Europe**  
Telephone: 31(0)183-696969  
Fax: 31(0)183-629055  
E-mail: order@edc.katun.com

















OEM PN	KATUN PN	DESCRIPTION	MODEL NO.	
<b>Picker Fingers</b>				
FB1-0301-000	15013734 	<b>Upper Picker Finger</b>	FC 3, FC 3 II, FC 5, FC 5 II, NP 1010, NP 1015, NP 1020, NP 1215, NP 1318, NP 1510, NP 1520, NP 1530, NP 1550, NP 2010, NP 6010, NP 6020, NP 6116, NP 6216, NP 6220, NP 6317, NP 6318, NP 6320, NP 6621, PC 6, PC 7, PC 8, PC 11	<i>Priced per Picker Finger, sold in Bags of 5.</i>
FA2-9037-000	15242562 	<b>Lower Picker Finger</b>	GP 30 F, GP 55, GP 55 F, GP 55 II, GP 285, GP 335, GP 405, GP 555, GP 605, iR 85, iR 105, iR 400, iR 5000, iR 5000 i, iR 5020 i, iR 5020 IN, iR 6000, iR 6000 i, iR 6020 I, iR 7200, iR 8500, NP 150, NP 155, NP 155 DF, NP 1015, NP 1215, NP 1318, NP 1510, NP 1520, NP 1530, NP 1550, NP 2010, NP 2015, NP 2015 F, NP 2017, NP 2020, NP 2120, NP 2215, NP 3020, NP 3025, NP 3030, NP 3050, NP 3225, NP 3325, NP 3525, NP 3725, NP 3825, NP 3825 II, NP 4050, NP 4080, NP 4335, NP 4835, NP 4835 i, NP 6020, NP 6025, NP 6028, NP 6030, NP 6035, NP 6035 F, NP 6045, NP 6050, NP 6050 ER, NP 6116, NP 6216, NP 6220, NP 6221, NP 6241, NP 6251, NP 6260, NP 6317, NP 6318, NP 6320, NP 6330, NP 6350, NP 6360, NP 6825 DADF, NP 6826 DADF, NP 6831, NP 6835 RDF, NP 7160, NP 7161, NP 7164, NP 7500	<i>Priced per Picker Finger, sold in Bags of 10.</i>
FB1-7075-000	15013099 	<b>Upper Picker Finger</b>	GP 30 F, GP 55, GP 55 F, GP 55 II, GP 285, GP 335, GP 405, iR 400, NP 4050, NP 4080, NP 6025, NP 6028, NP 6030, NP 6035, NP 6035 F, NP 6241, NP 6330, NP 7160, NP 7161, NP 7164	<i>Priced per Picker Finger, sold in Packages of 10.</i>
FC1-0391-040	15016086 	<b>Upper Picker Finger</b>	GP 555, GP 605	<i>Priced per Picker Finger, sold in Bags of 10.</i>
FB4-8018-000	15015367 	<b>Drum Picker Finger</b>	GP 555, GP 605, iR 85, iR 105, iR 7200, iR 8500	<i>Priced per Picker Finger, sold in Packages of 4.</i>
FB2-6899-000	15016793 	<b>Drum Picker Finger</b>	iR 5000, iR 5000 i, iR 5020 i, iR 5020 IN, iR 6000, iR 6000 i, iR 6020 I, NP 6045, NP 6050, NP 6050 ER, NP 6251, NP 6260, NP 6350, NP 6360, NP 7500	<i>Priced per Picker Finger, sold in Boxes of 3.</i>
FA3-1937-020	15015367 	<b>Drum Picker Finger</b>	NP A2 SV, NP A2 SV II, NP 5020, NP 5060, NP 6060, NP 6062, NP 6085, NP 6150, NP 6285, NP 6650, NP 6850, NP 6880, NP 6885, NP 7050, NP 7550, NP 8070, NP 8530, NP 8570, NP 8580, NP 9085, NP 9330, NP 9800	<i>Priced per Picker Finger, sold in Packages of 4.</i>
FA3-6323-000	15013099 	<b>Upper Picker Finger</b>	NP 150, NP 155, NP 155 DF, NP 270, NP 271, NP 275, NP 305	<i>Priced per Picker Finger, sold in Packages of 10.</i>
FA2-8345-000	15013097 	<b>Lower Picker Finger</b>	NP 270, NP 271, NP 275, NP 305, NP 4040, NP 4540, NP 5020, NP 5060, NP 6060, NP 6062, NP 6085, NP 6150, NP 6285, NP 6650, NP 6850, NP 9085	<i>Priced per Picker Finger, sold in Packages of 5.</i>



















OEM PN	KATUN PN	DESCRIPTION	MODEL NO.	
<b>Picker Fingers</b>				
FA6-5433-000	15013734 	<b>Upper Picker Finger</b>	NP 2020, NP 2120, NP 3020, NP 6221	<i>Priced per Picker Finger, sold in Bags of 5.</i>
FA3-8577-030 <i>Final Inventory</i>	15014465 	<b>Drum Picker Finger</b>	NP 3025, NP 3030, NP 3050, NP 3225, NP 3325, NP 3525, NP 3725, NP 3825, NP 3825 II, NP 4050, NP 4080, NP 4335, NP 4835 i, NP 6241, NP 6825 DADF, NP 6826 DADF, NP 6831, NP 6835 RDF	<i>Priced per Picker Finger, sold in Packages of 4.</i>
FA9-0451-000	15013099 	<b>Upper Picker Finger</b>	NP 3025, NP 3030, NP 3050, NP 3225, NP 3325, NP 3525, NP 3725, NP 3825, NP 3825 II, NP 4335, NP 4835, NP 4835 i, NP 6825 DADF, NP 6826 DADF, NP 6831, NP 6835 RDF	<i>Priced per Picker Finger, sold in Packages of 10.</i>
FC1-0391-030	15016086 	<b>Upper Picker Finger</b>	NP 4040, NP 4540, NP 5020, NP 5060, NP 6045, NP 6050, NP 6050 ER, NP 6060, NP 6062, NP 6085, NP 6150, NP 6251, NP 6260, NP 6285, NP 6350, NP 6360, NP 6650, NP 6850, NP 6880, NP 7050, NP 7500, NP 7550, NP 8070, NP 8570, NP 8580, NP 9085	<i>Priced per Picker Finger, sold in Bags of 10.</i>
FA3-2762-050	15242560 	<b>Upper Picker Finger</b>	NP 4040, NP 4540, NP 5020, NP 5060, NP 6150, NP 6650, NP 6850, NP 6880, NP 7050, NP 7550, NP 8070, NP 8570, NP 8580	<i>Priced per Picker Finger, sold in Packages of 10.</i>
1129037-020	15242562 	<b>Lower Picker Finger</b>	NP 6330	<i>Priced per Picker Finger, sold in Bags of 10.</i>
FA6-4296-000	15014198 	<b>Upper Picker Finger</b>	NP 6885, NP 8530, NP 9800	<i>Priced per Picker Finger, sold in Packages of 5.</i>

For use in  
**Canon**  
 Copiers

**Central/Eastern Europe**  
 Telephone: 31(0)183-696969  
 Fax: 31(0)183-629055  
 E-mail: order@edc.katun.com

OEM PN	KATUN PN	DESCRIPTION	MODEL NO.
<b>Rollers, Fuser/Heat</b>			
FB1-9435-000 <i>Final Inventory</i>	15016195 	<b>Upper Fuser Roller</b> Silicone Based	CLC 320, CLC 350, CLC 550
FB4-6597-000	15022701 	<b>Upper Fuser Roller</b> Silicone Based	CLC 700, CLC 700 E, CLC 700 L, CLC 700 S, CLC 800, CLC 800 S, CLC 900, CLC 920, CLC 950, CLC 1000, CLC 1000 S, CLC 3100
FB4-4484-000	15022568 	<b>Upper Fuser Roller</b> Silicone Based	CLC 1100, CLC 1130, CLC 1150
FB1-0241-000	15636775 	<b>Upper Fuser Roller</b> <b>DURAPREM™ II</b>	FC 3, FC 3 II, FC 5, FC 5 II
FB2-6519-000	15013794 	<b>Upper Fuser Roller</b> OEM Type	GP 30 F
FB1-6818-000	15013794 	<b>Upper Fuser Roller</b> OEM Type	GP 55, GP 55 F, GP 55 II
FB5-0289-000	15017998 	<b>Upper Fuser Roller</b> <b>TRITON™ II</b>	GP 335, GP 405, iR 400
FB2-7200-000	15014109 	<b>Upper Fuser Roller</b> <b>TUF/SIL™</b> OEM Type Silicone Upper Fuser Roller	GP 555, GP 605, NP 6045, NP 6050, NP 6050 ER, NP 6251, NP 6350, NP 7500
FB2-7200-000	15013796 	<b>Upper Fuser Roller</b> <b>TRITON™ II</b>	GP 555, GP 605, NP 6045, NP 6050, NP 6050 ER, NP 6251, NP 6350, NP 7500
FB5-6930-000	15021897 	<b>Upper Fuser Roller</b> <b>TUF/SIL™</b> OEM Type Silicone Upper Fuser Roller	iR 85, iR 105, iR 7200, iR 8500
FB5-8132-010	15022273 	<b>Upper Fuser Roller</b>	iR 1600, iR 1610 F, iR 2000, iR 2010 F
RB2-3521-000	15017612 	<b>Upper Fuser Roller</b>	iR 3250
FB4-3690-000	15016675 	<b>Upper Fuser Roller</b> <b>TUF/SIL™</b> OEM Type Silicone Upper Fuser Roller	iR 5000, iR 5000 i, iR 5020 i, IR 5020 IN, iR 6000, iR 6000 i, IR 6020 I, NP 6260, NP 6360
FB4-3690-000	15016189 	<b>Upper Fuser Roller</b> <b>TRITON™ II</b>	iR 5000, iR 5000 i, iR 5020 i, IR 5020 IN, iR 6000, iR 6000 i, IR 6020 I, NP 6260, NP 6360
FB1-9212-00E	15636871 	<b>Upper Fuser Roller</b> <b>DURACON™ II</b>	NP 1010, NP 1020, NP 6010, PC 6, PC 7, PC 8, PC 11
FB1-9212-00E	15016033 	<b>Upper Fuser Roller</b> OEM Type (Blue)	NP 1010, NP 1020, NP 6010, PC 6, PC 7, PC 8, PC 11
FA5-1916-05E	15636870 	<b>Upper Fuser Roller</b> <b>DURACON™ II</b>	NP 1015, NP 1215, NP 1318, NP 1510, NP 1520, NP 1530, NP 1550, NP 2010, NP 6116, NP 6216, NP 6318









OEM PN	KATUN PN	DESCRIPTION	MODEL NO.
<b>Rollers, Fuser/Heat</b>			
FA5-1916-05E	15014369 	<b>Upper Fuser Roller</b> OEM Type (Blue)	NP 1015, NP 1215, NP 1318, NP 1510, NP 1520, NP 1530, NP 1550, NP 2010, NP 6116, NP 6216, NP 6318
FA6-5361-030	15012374 	<b>Upper Fuser Roller</b> <b>DURACON™ II</b>	NP 2020, NP 2120, NP 3020, NP 6020, NP 6220, NP 6221
FA6-5361-030	15016034 	<b>Upper Fuser Roller</b> OEM Type (Blue)	NP 2020, NP 2120, NP 3020, NP 6020, NP 6220, NP 6221
FA3-8866-00E	15636303 	<b>Upper Fuser Roller</b> <b>DURACON™ II</b>	NP 3025, NP 3225, NP 3525, NP 3725
FA6-3024-04E	15013792 	<b>Upper Fuser Roller</b>	NP 3030, NP 3050, NP 3325, NP 3825, NP 3825 II, NP 6825 DADF, NP 6826 DADF, NP 6831
FA4-0561-030 <i>Final Inventory</i>	15013210 	<b>Upper Fuser Roller</b> <b>TUF/SIL™</b> OEM Type Silicone Upper Fuser Roller	NP 4040, NP 4540
FA4-0561-030	15012725 	<b>Upper Fuser Roller</b> <b>TRITON™ II</b>	NP 4040, NP 4540
FB1-5948-00E	15013793 	<b>Upper Fuser Roller</b> <b>TRITON™ II</b>	NP 4050, NP 4080, NP 4335, NP 4835, NP 4835 i, NP 6241, NP 6835 RDF
FB1-5948-00E	15014831	<b>Upper Fuser Roller</b> <b>Access By Katun</b>	NP 4050, NP 4080, NP 4335, NP 4835, NP 4835 i, NP 6241, NP 6835 RDF
FA5-7730-000 <i>Final Inventory</i>	15013210 	<b>Upper Fuser Roller</b> <b>TUF/SIL™</b> OEM Type Silicone Upper Fuser Roller	NP 5020, NP 5060, NP 6150, NP 6650, NP 6850
FA5-7730-000	15012725 	<b>Upper Fuser Roller</b> <b>TRITON™ II</b>	NP 5020, NP 5060, NP 6150, NP 6650, NP 6850
FB1-7956-00E	15013794 	<b>Upper Fuser Roller</b> OEM Type	NP 6025, NP 6030, NP 6330
FB3-6936-000	15014802 	<b>Upper Fuser Roller</b> <b>TRITON™ II</b>	NP 6028, NP 6035, NP 6035 F
FA6-7987-000	15013211 	<b>Upper Fuser Roller</b> <b>TUF/SIL™</b> OEM Type Silicone Upper Fuser Roller	NP 6060, NP 6062
FA6-7987-000	15013795 	<b>Upper Fuser Roller</b> <b>TRITON™ II</b>	NP 6060, NP 6062
FB1-9885-020	15013212 	<b>Upper Fuser Roller</b> <b>TUF/SIL™</b> OEM Type Silicone Upper Fuser Roller	NP 6085, NP 6285, NP 9085
FB1-9885-020	15012727 	<b>Upper Fuser Roller</b> <b>TRITON™ II</b>	NP 6085, NP 6285, NP 9085



For use in  
**Canon**  
 Copiers

**Central/Eastern Europe**  
 Telephone: 31(0)183-696969  
 Fax: 31(0)183-629055  
 E-mail: order@edc.katun.com

OEM PN	KATUN PN	DESCRIPTION	MODEL NO.
<b>Rollers, Fuser/Heat</b>			
FC2-9961-00P	15020850 	<b>Upper Fuser Roller</b>	NP 6317, NP 6320
1153714-0001	15013212 	<b>Upper Fuser Roller</b> <b>TUF/SIL™</b> OEM Type Silicone Upper Fuser Roller	NP 6880, NP 8070, NP 8570, NP 8580, NP 9800
1153714-0001	15012727 	<b>Upper Fuser Roller</b> <b>TRITON™ II</b>	NP 6880, NP 8070, NP 8570, NP 8580, NP 9800
FA5-3714-000	15013212 	<b>Upper Fuser Roller</b> <b>TUF/SIL™</b> OEM Type Silicone Upper Fuser Roller	NP 6880, NP 8070, NP 8570, NP 8580, NP 9800
FA5-3714-000	15012727 	<b>Upper Fuser Roller</b> <b>TRITON™ II</b>	NP 6880, NP 8070, NP 8570, NP 8580, NP 9800
FG2-2180-000	15013213 	<b>Upper Fuser Roller</b> <b>TUF/SIL™</b> OEM Type Silicone Upper Fuser Roller	NP 6885, NP 8530, NP 9800
FA2-5936-060	15636302 	<b>Upper Fuser Roller</b> <b>DURAPREM™ II</b> For use with Thermal Switch.	PC 10, PC 12 (EU), PC 14, PC 15, PC 20, PC 22, PC 24, PC 25



















OEM PN	KATUN PN	DESCRIPTION	MODEL NO.
<b>Rollers, Pressure</b>			
FB1-9436-000	15016196 ◆	<b>Lower Pressure Roller</b> Silicone Based	CLC 320, CLC 350, CLC 550
FB4-6598-000	15022702 ◆	<b>Lower Pressure Roller</b> Silicone Based	CLC 700, CLC 700 E, CLC 700 L, CLC 700 S, CLC 800, CLC 800 S, CLC 900, CLC 920, CLC 950, CLC 1000, CLC 1000 S, CLC 3100
FB4-4486-000	15022569 ◆	<b>Lower Pressure Roller</b> Silicone Based	CLC 1100, CLC 1130, CLC 1150
FB1-0242-000 <i>Final Inventory</i>	15636778 ◆	<b>Lower Pressure Roller</b> Foam Type	FC 3, FC 3 II, FC 5, FC 5 II
FB1-8767-000	15013060 ◆	<b>Lower Pressure Roller</b> <b>MICROSLEEVE™</b>	GP 30 F, GP 55, GP 55 F, GP 55 II
RB2-1919-000	15020977 ◆	<b>Lower Pressure Roller</b> <b>MICROSLEEVE™</b>	GP 160, GP 160 F
RB2-1919-000	15020998 ◆	<b>Lower Pressure Roller</b> <b>MICROSLEEVE™</b>	GP 160, GP 160 F
FB4-2867-000	15020948 ◆	<b>Lower Pressure Roller</b> <b>MICROSLEEVE™</b>	GP 285, GP 335, GP 405, iR 400
FB4-2220-000	15020949 ◆	<b>Lower Pressure Roller</b> <b>MICROSLEEVE™</b>	GP 555, GP 605
FB5-6952-000	15022087 ◆	<b>Lower Pressure Roller</b> <b>MICROSLEEVE™</b>	iR 85, iR 105, iR 7200, iR 8500
FB6-1549-000	15023033 ◆	<b>Lower Pressure Roller</b> <b>MICROSLEEVE™</b>	iR 1600, iR 1610 F, iR 2000, iR 2010 F
FB5-4942-000	15022660 ◆	<b>Lower Pressure Roller</b> <b>MICROSLEEVE™</b>	iR 2200, iR 2200 i, iR 2800, IR 2800 I, iR 3300, iR 3300 i
FB5-3619-000	15021725 ◆	<b>Lower Pressure Roller</b> <b>MICROSLEEVE™</b>	iR 5000, iR 5000 i, iR 5020 i, IR 5020 IN, iR 6000, iR 6000 i, IR 6020 I
FB5-1132-000	15021987 ◆	<b>Lower Pressure Roller</b> <b>MICROSLEEVE™</b>	IR C 2100, iR C 2100 S, iR C 2105
FB9-0002-000	15636886 ◆	<b>Lower Pressure Roller</b> New styleFor use without thrust collars.	NP 1010, NP 1020, NP 6010, PC 7, PC 8, PC 11
FA6-3921-00E	15013060 ◆	<b>Lower Pressure Roller</b> <b>MICROSLEEVE™</b>	NP 1015, NP 1215, NP 1318, NP 1510, NP 1520, NP 1530, NP 1550, NP 2010, NP 2020, NP 2120, NP 3020, NP 3030, NP 3050, NP 3325, NP 3825, NP 3825 II, NP 6116, NP 6216, NP 6221, NP 6318, NP 6825 DADF, NP 6826 DADF, NP 6831
FA0-0330-00P	15013060 ◆	<b>Lower Pressure Roller</b> <b>MICROSLEEVE™</b>	NP 1530, NP 1550, NP 6020, NP 6116, NP 6216, NP 6220
FA5-1501-00E	15008768 ◆	<b>Lower Pressure Roller</b> <b>MICROSLEEVE™</b>	NP 3025, NP 3225, NP 3525, NP 3725, NP 6025, NP 6030

*Priced per Pressure Roller,  
 sold in Boxes of 25.*

For use in  
**Canon**  
 Copiers

**Central/Eastern Europe**  
 Telephone: 31(0)183-696969  
 Fax: 31(0)183-629055  
 E-mail: order@edc.katun.com

OEM PN	KATUN PN	DESCRIPTION	MODEL NO.
<b>Rollers, Pressure</b>			
FA4-0562-000	15636389 	<b>Lower Pressure Roller MICROSLEEVE™</b> 50µ PFA Sleeve	NP 4040, NP 4540
FB1-5921-030 <i>Final Inventory</i>	15010400 	<b>Lower Pressure Roller MICROSLEEVE™</b>	NP 4050, NP 4080, NP 6241
FA5-5156-000	15636389 	<b>Lower Pressure Roller MICROSLEEVE™</b> 50µ PFA Sleeve	NP 5020, NP 5060, NP 6150, NP 6650, NP 6850
FY1-0807-000	15019954 	<b>Lower Pressure Roller MICROSLEEVE™</b>	NP 5020, NP 5060, NP 6150, NP 6650, NP 6850
FB2-5043-000	15016957 	<b>Lower Pressure Roller MICROSLEEVE™</b>	NP 6012, NP 6112, NP 6212, NP 6312, PC 720, PC 740, PC 745, PC 750, PC 775, PC 780
FB2-2316-000 <i>Final Inventory</i>	15016960 	<b>Lower Pressure Roller MICROSLEEVE™</b>	NP 6016, NP 6218, NP 6521
FB1-7957-000	15008768 	<b>Lower Pressure Roller MICROSLEEVE™</b>	NP 6025, NP 6030, NP 6330
FB3-8102-000	15013905 	<b>Lower Pressure Roller MICROSLEEVE™</b>	NP 6028, NP 6035, NP 6035 F
FB2-7121-00V	15013905 	<b>Lower Pressure Roller MICROSLEEVE™</b>	NP 6028, NP 6035, NP 6035 F, NP 6045, NP 6050, NP 6050 ER, NP 6251, NP 6350, NP 7500
FC1-2026-000	15019953 	<b>Lower Pressure Roller MICROSLEEVE™</b>	NP 6060, NP 6062
FB1-9886-000	15016077 	<b>Lower Pressure Roller MICROSLEEVE™</b>	NP 6085, NP 6285, NP 9085
FB3-9164-000	15021563 	<b>Lower Pressure Roller</b>	NP 6260, NP 6360
FC2-8962-00P	15021855 	<b>Lower Pressure Roller MICROSLEEVE™</b>	NP 6317, NP 6320, NP 6621
FB4-9878-000	15019852 	<b>Lower Pressure Roller MICROSLEEVE™</b>	NP 6512, NP 6612, NP 7130, NP 7130 F
FA5-7676-000	15636889 	<b>Lower Pressure Roller MICROSLEEVE™</b>	NP 6880, NP 8580
FA6-4282-000	15636889 	<b>Lower Pressure Roller MICROSLEEVE™</b>	NP 6885, NP 8530, NP 9800
FY1-0805-000	15636889 	<b>Lower Pressure Roller MICROSLEEVE™</b>	NP 7050, NP 7550, NP 8070, NP 8570



Central/Eastern Europe  
Telephone: 31(0)183-696969  
Fax: 31(0)183-629055  
E-mail: order@edc.katun.com

For use in  
**Canon**  
Copiers

OEM PN	KATUN PN	DESCRIPTION	MODEL NO.
-----------	-------------	-------------	--------------

## Seals



FA5-1684-000	15008893 	Cleaning Blade Seal Tape	NP 1015, NP 1215, NP 1318, NP 1510, NP 1520, NP 1530, NP 1550, NP 2010, NP 2020, NP 2120, NP 6020, NP 6116, NP 6216, NP 6220, NP 6221, NP 6318
--------------	---	-----------------------------	---





For use in  
**Canon**  
 Copiers

**Central/Eastern Europe**  
 Telephone: 31(0)183-696969  
 Fax: 31(0)183-629055  
 E-mail: order@edc.katun.com

OEM PN	KATUN PN	DESCRIPTION	MODEL NO.
--------	----------	-------------	-----------





## Springs

97-5527-000	15524647 	<b>Corona Wire Spring</b> Stainless Steel Various Applications Various Applications	IMAGERUNNER C 6800, IR C 6800, IR C 6800 N CLC 1, CLC 200, CLC 300, CLC 320, CLC 350, CLC 500, CLC 550, CLC 700, CLC 700 E, CLC 700 L, CLC 700 S, CLC 800, CLC 800 S, CLC 900, CLC 920, CLC 950, CLC 1000, CLC 1000 S, CLC 1100, CLC 1130, CLC 1150, CLC 3100, CLC 4000, CLC 5000, CLC 5100, FC 1, FC 2, FC 3, FC 3 II, FC 5, FC 22, GP 30 F, GP 55, GP 55 F, GP 55 II, GP 555, GP 605, iR 85, iR 105, iR 5000, iR 5000 i, iR 5020 i, IR 5020 IN, iR 6000, iR 6000 i, IR 6020 I, iR 7200, iR 8500, NP 115, NP 120, NP 125, NP 126, NP 150, NP 155, NP 155 DF, NP 200, NP 210, NP 270, NP 271, NP 275, NP 300, NP 305, NP 400, NP 402, NP 500, NP 505, NP 1010, NP 1015, NP 1020, NP 1215, NP 1318, NP 1510, NP 1520, NP 1530, NP 1550, NP 2010, NP 2015, NP 2015 F, NP 2017, NP 2020, NP 2120, NP 2215, NP 3020, NP 3025, NP 3030, NP 3050, NP 3225, NP 3325, NP 3525, NP 3725, NP 3825, NP 3825 II, NP 4040, NP 4050, NP 4080, NP 4335, NP 4540, NP 4835, NP 4835 i, NP 5020, NP 5060, NP 6010, NP 6020, NP 6045, NP 6050, NP 6050 ER, NP 6060, NP 6062, NP 6085, NP 6116, NP 6150, NP 6216, NP 6220, NP 6221, NP 6241, NP 6251, NP 6260, NP 6285, NP 6317, NP 6318, NP 6320, NP 6330, NP 6350, NP 6360, NP 6650, NP 6825 DADF, NP 6826 DADF, NP 6831, NP 6835 RDF, NP 6850, NP 6880, NP 6885, NP 7050, NP 7160, NP 7161, NP 7164, NP 7500, NP 7550, NP 8070, NP 8530, NP 8570, NP 8580, NP 9030, NP 9085, NP 9330, NP 9800, PC 6, PC 7, PC 8, PC 10, PC 11, PC 12 (EU), PC 14, PC 15, PC 20, PC 22, PC 24, PC 25	<i>Priced per Spring, sold in Bags of 10.</i>
FS2-2763-000	15524647 	<b>Corona Wire Spring</b> Stainless Steel Charge	GP 30 F, GP 55, GP 55 F, GP 55 II, NP 1015, NP 1215, NP 1510, NP 1520, NP 2010, NP 2020, NP 2120, NP 3020, NP 6221, NP 6317, NP 6318, NP 6320, NP 6330	<i>Priced per Spring, sold in Bags of 10.</i>

OEM PN	KATUN PN	DESCRIPTION	MODEL NO.
<b>Thermal Control Devices</b>			
FH7-7463-000	15017296 	<b>Thermistor</b>	GP 555, GP 605
FH7-7464-000	15017297 	<b>Thermistor 2</b>	GP 555, GP 605, iR 85, iR 105, iR 7200, iR 8500
FH7-7349-000	15013160 	<b>Thermistor</b>	NP 6045, NP 6050, NP 6050 ER, NP 6251, NP 6260, NP 6350, NP 6360, NP 7500
FH7-7252-000	15013705 	<b>Thermistor</b>	NP 6060, NP 6062

For use in  
**Canon**  
Copiers

**Central/Eastern Europe**  
Telephone: 31(0)183-696969  
Fax: 31(0)183-629055  
E-mail: order@edc.katun.com

OEM PN	KATUN PN	DESCRIPTION	MODEL NO.	
<b>Toners/Toner Cartridges</b>				
1437A001AA <i>Final Inventory</i>	15019905	<b>Yellow Toner</b> <b>Access By Katun</b> 345 g / Cartridge 4 Cartridges per Master Carton	CLC 200, CLC 300, CLC 320, CLC 350	<i>Priced per Cartridge, sold per Cartridge.</i>
F41-6801-000 <i>Final Inventory</i>	15019902	<b>Black Toner</b> <b>Access By Katun</b> 345 g / Cartridge 4 Cartridges per Master Carton	CLC 200, CLC 300, CLC 320, CLC 350	<i>Priced per Cartridge, sold per Cartridge.</i>
F41-6831-000 <i>Final Inventory</i>	15019905	<b>Yellow Toner</b> <b>Access By Katun</b> 345 g / Cartridge 4 Cartridges per Master Carton	CLC 200, CLC 300, CLC 320, CLC 350	<i>Priced per Cartridge, sold per Cartridge.</i>
1420A001AA <i>Final Inventory</i>	15019906	<b>Black Toner</b> <b>Access By Katun</b> 600 g / Cartridge 4 Cartridges per Master Carton	CLC 500, CLC 550	<i>Priced per Cartridge, sold per Cartridge.</i>
1426A001AA <i>Final Inventory</i>	15019907	<b>Cyan Toner</b> <b>Access By Katun</b> 600 g / Cartridge 4 Cartridges per Master Carton	CLC 500, CLC 550	<i>Priced per Cartridge, sold per Cartridge.</i>
1432A001AA <i>Final Inventory</i>	15019908	<b>Magenta Toner</b> <b>Access By Katun</b> 600 g / Cartridge 4 Cartridges per Master Carton	CLC 500, CLC 550	<i>Priced per Cartridge, sold per Cartridge.</i>
1438A001AA <i>Final Inventory</i>	15019909	<b>Yellow Toner</b> <b>Access By Katun</b> 600 g / Cartridge 4 Cartridges per Master Carton	CLC 500, CLC 550	<i>Priced per Cartridge, sold per Cartridge.</i>
F42-0401-600	15015717 	<b>Black Toner</b> 345 g / Cartridge 12 Cartridges per Master Carton	CLC 700, CLC 700 E, CLC 700 L, CLC 700 S, CLC 800, CLC 800 S, CLC 900, CLC 920, CLC 950	<i>Priced per Cartridge, sold per Cartridge.</i>
F42-0411-600	15015718 	<b>Cyan Toner</b> 345 g / Cartridge 12 Cartridges per Master Carton	CLC 700, CLC 700 E, CLC 700 L, CLC 700 S, CLC 800, CLC 800 S, CLC 900, CLC 920, CLC 950	<i>Priced per Cartridge, sold per Cartridge.</i>
F42-0421-600	15015719 	<b>Magenta Toner</b> 345 g / Cartridge 12 Cartridges per Master Carton	CLC 700, CLC 700 E, CLC 700 L, CLC 700 S, CLC 800, CLC 800 S, CLC 900, CLC 920, CLC 950	<i>Priced per Cartridge, sold per Cartridge.</i>
F42-0431-600	15015720 	<b>Yellow Toner</b> 345 g / Cartridge 12 Cartridges per Master Carton	CLC 700, CLC 700 E, CLC 700 L, CLC 700 S, CLC 800, CLC 800 S, CLC 900, CLC 920, CLC 950	<i>Priced per Cartridge, sold per Cartridge.</i>
1422A004AA	15022055	<b>Black Toner</b> <b>Original</b> 640 g / Cartridge	CLC 1000, CLC 1000 S, CLC 3100	
1428A004AA	15022056	<b>Cyan Toner</b> <b>Original</b> 750 g / Cartridge	CLC 1000, CLC 1000 S, CLC 3100	





Katun Performance Product

© 2004 Katun Corporation

**13 September 2004** For the most current product and pricing information, visit the Katun On-Line Catalog at [www.katun.com](http://www.katun.com).

Prices, terms and conditions are subject to change without notice.

OEM PN	KATUN PN	DESCRIPTION	MODEL NO.
<b>Toners/Toner Cartridges</b>			
1434A004AA	15022057	<b>Magenta Toner Original</b> 750 g / Cartridge	CLC 1000, CLC 1000 S, CLC 3100
1440A004AA	15022058	<b>Yellow Toner Original</b> 750 g / Cartridge	CLC 1000, CLC 1000 S, CLC 3100
F42-0505-600	15022055	<b>Black Toner Original</b> 640 g / Cartridge	CLC 1000, CLC 1000 S, CLC 3100
F42-0515-600	15022056	<b>Cyan Toner Original</b> 750 g / Cartridge	CLC 1000, CLC 1000 S, CLC 3100
F42-0525-600	15022057	<b>Magenta Toner Original</b> 750 g / Cartridge	CLC 1000, CLC 1000 S, CLC 3100
F42-0535-600	15022058	<b>Yellow Toner Original</b> 750 g / Cartridge	CLC 1000, CLC 1000 S, CLC 3100
F41-4102-020	15015523 	<b>Black PC Toner Cartridge</b> Equivalent to A30 1 Cartridge per Master Carton	FC 1, FC 2, FC 3, FC 3 II, FC 5, FC 5 II, FC 22, PC 6, PC 7, PC 7 RE, PC 8, PC 11
F41-4102-020	15013778	<b>Black PC Toner Cartridge Original</b>	FC 1, FC 2, FC 3, FC 3 II, FC 5, FC 5 II, FC 22, PC 6, PC 7, PC 7 RE, PC 8, PC 11
N/P/N	15012018	<b>Black Toner Access By Katun</b> 185 g / Bottle 1 Box (30 Bottles) per Master Carton	FC 1, FC 2, FC 3, FC 5, FC 22, PC 10, PC 12 (EU), PC 14, PC 15, PC 20, PC 22, PC 24, PC 25
F41-8802-090	15014626	<b>Black PC Toner Cartridge Original</b> 150 g / Cartridge	FC 200, FC 210, FC 220, FC 230, FC 310, FC 325, FC 330, FC 336, FC 530, PC 425
3842A002AA	15018333 	<b>Printer Toner Cartridge</b> Contains New OPC Drum Equivalent to 29X/EP-62 1 Cartridge per Master Carton	GP 160, GP 160 F, imageCLASS 2250
3842A002AA	15024390	<b>Printer Toner Cartridge Original</b>	GP 160, GP 160 F, imageCLASS 2250
3842A002AA	15023088	<b>Printer Toner Cartridge Original</b>	GP 160, GP 160 F, imageCLASS 2250
1388A010AA	15022529 	<b>Black Toner</b> 530 g / Cartridge 10 Cartridges per Master Carton	GP 210, GP 215, GP 220, GP 225

*Priced per Cartridge,  
 sold per Cartridge.*

*Priced per Bottle,  
 sold in Boxes of 30.*

*Priced per Cartridge,  
 sold per Cartridge.*









*Priced per Cartridge,  
 sold in Boxes of 2.*

*Priced per Cartridge,  
 sold per Cartridge.*







For use in  
**Canon**  
Copiers

**Central/Eastern Europe**  
Telephone: 31(0)183-696969  
Fax: 31(0)183-629055  
E-mail: order@edc.katun.com

OEM PN	KATUN PN	DESCRIPTION	MODEL NO.	
<b>Toners/Toner Cartridges</b>				
1388A010AA	15017698	<b>Black Toner</b> <b>Original</b> 530 g / Cartridge	GP 210, GP 215, GP 220, GP 225	
F42-1401-000	15022529 	<b>Black Toner</b> 530 g / Cartridge 10 Cartridges per Master Carton	GP 210, GP 215, GP 220, GP 225	<i>Priced per Cartridge, sold per Cartridge.</i>
1389A004AA	15022529 	<b>Black Toner</b> 530 g / Cartridge 10 Cartridges per Master Carton	GP 285, GP 335, GP 405, iR 400	<i>Priced per Cartridge, sold per Cartridge.</i>
F42-3201-600	15022529 	<b>Black Toner</b> 530 g / Cartridge 10 Cartridges per Master Carton	GP 285, GP 335, GP 405, iR 400	<i>Priced per Cartridge, sold per Cartridge.</i>
F42-3201-700	15022529 	<b>Black Toner</b> 530 g / Cartridge 10 Cartridges per Master Carton	GP 285, GP 335, GP 405, iR 400	<i>Priced per Cartridge, sold per Cartridge.</i>
1390A003AA	15022517 	<b>Black Toner</b> 1650 g / Cartridge 1 Carton (3 Cartridges) per Master Carton	GP 555, GP 605, iR 7200	<i>Priced per Cartridge, sold in Cartons of 3.</i>
6748A003AA	15023087	<b>Black Toner</b> <b>Original</b> 1650 g / Cartridge	iR 85, iR 105, iR 8500	<i>Priced per Box, 2 Cartridges per Box.</i>
7814A003AA	15023086	<b>Black Toner</b> <b>Original</b>	iR 1210, iR 1230, iR 1270 F, IR 1630, IR 1670 F	
6836A003AA	15023083	<b>Black Toner</b> <b>Original</b> 440 g / Cartridge	iR 1600, iR 2000, iR 2010 F	<i>Priced per Box, 2 Cartridges per Box.</i>
6647A003AA	15021556 	<b>Black Toner</b> 795 g / Cartridge 6 Cartridges per Master Carton	iR 2200, iR 2200 i, iR 2800, IR 2800 I, iR 3300, iR 3300 i	<i>Priced per Cartridge, sold per Cartridge.</i>
6647A003AA	15023081	<b>Black Toner</b> <b>Original</b> 795 g / Cartridge	iR 2200, iR 2200 i, iR 2800, IR 2800 I, iR 3300, iR 3300 i	
3845A002AA	15018335 	<b>Printer Toner Cartridge</b> Equivalent to 82X/EP-72 Contains New OPC Drum 1 Cartridge per Master Carton	iR 3250	<i>Priced per Cartridge, sold per Cartridge.</i>
4234A003AA	15020802 	<b>Black Toner</b> 1650 g / Cartridge 6 Cartridges per Master Carton	iR 5000, iR 5000 i, iR 6000, iR 6000 i	<i>Priced per Cartridge, sold per Cartridge.</i>
4234A003AA	15023085	<b>Black Toner</b> <b>Original</b> 1650 g / Cartridge	iR 5000, iR 5000 i, iR 6000, iR 6000 i	
4234A003AB	15020802 	<b>Black Toner</b> 1650 g / Cartridge 6 Cartridges per Master Carton	iR 5000, iR 5000 i, iR 6000, iR 6000 i	<i>Priced per Cartridge, sold per Cartridge.</i>



OEM PN	KATUN PN	DESCRIPTION	MODEL NO.	
<b>Toners/Toner Cartridges</b>				
1369A009AA	15008986 	<b>Black Toner</b> 105 g / Cartridge Includes: • (1)Fuser Roller Cleaning Felt Assembly 20 Boxes (40 Cartridges) per Master Carton	NP 1010, NP 1020, NP 6010	<i>Priced per Box, 2 Cartridges per Box.</i>
1369A009AA	15011998	<b>Black Toner</b> <b>Access By Katun</b> 105 g / Cartridge Includes: • (1)Fuser Roller Cleaning Felt Assembly 20 Boxes (40 Cartridges) per Master Carton	NP 1010, NP 1020, NP 6010	<i>Priced per Box, 2 Cartridges per Box.</i>
F41-5902-100	15017858 	<b>Black Toner</b> 190 g / Cartridge Equivalent to G-1 12 Boxes (48 Cartridges) per Master Carton	NP 1015, NP 1215, NP 1318, NP 1510, NP 1520, NP 1530, NP 1550, NP 2010, NP 2020, NP 2120, NP 6020, NP 6116, NP 6216, NP 6220, NP 6221, NP 6317, NP 6318	<i>Priced per Box, 4 Cartridges per Box.</i>
F41-5902-100	15017696	<b>Black Toner</b> <b>Original</b> 190 g / Cartridge	NP 1015, NP 1215, NP 1318, NP 1510, NP 1520, NP 1530, NP 1550, NP 2010, NP 2020, NP 2120, NP 6020, NP 6116, NP 6216, NP 6220, NP 6221, NP 6317, NP 6318	<i>Priced per Box, 4 Cartridges per Box.</i>
F41-5902-100	15022969	<b>Black Toner</b> <b>Access By Katun</b> 190 g / Cartridge 12 Boxes (48 Cartridges) per Master Carton	NP 1015, NP 1215, NP 1318, NP 1510, NP 1520, NP 1530, NP 1550, NP 2010, NP 2020, NP 2120, NP 6020, NP 6116, NP 6216, NP 6220, NP 6221, NP 6317, NP 6318	<i>Priced per Cartridge, sold in Boxes of 4.</i>
1378A001AA	15017868 	<b>Black Toner</b> 190 g / Cartridge Equivalent to G-8 12 Boxes (48 Cartridges) per Master Carton	NP 3020	<i>Priced per Box, 4 Cartridges per Box.</i>
1363A002AA	15807871 	<b>Black Toner</b> 350 g / Cartridge 12 Boxes (24 Cartridges) per Master Carton	NP 3025, NP 3225, NP 3525, NP 3725	<i>Priced per Box, 2 Cartridges per Box.</i>
1376A003AB	15017782 	<b>Black Toner</b> 680 g / Cartridge Equivalent to G-5 8 Cartridges per Master Carton	NP 3030, NP 3050	<i>Priced per Cartridge, sold per Cartridge.</i>
1376A003AB	15017783	<b>Black Toner</b> <b>Access By Katun</b> 680 g / Cartridge 8 Cartridges per Master Carton	NP 3030, NP 3050	<i>Priced per Cartridge, sold per Cartridge.</i>
F41-8201-000	15017782 	<b>Black Toner</b> 680 g / Cartridge Equivalent to G-5 8 Cartridges per Master Carton	NP 3030, NP 3050	<i>Priced per Cartridge, sold per Cartridge.</i>

For use in  
**Canon**  
 Copiers





**Central/Eastern Europe**  
 Telephone: 31(0)183-696969  
 Fax: 31(0)183-629055  
 E-mail: order@edc.katun.com

OEM PN	KATUN PN	DESCRIPTION	MODEL NO.	
<b>Toners/Toner Cartridges</b>				
F41-8201-000	15017783	<b>Black Toner</b> <b>Access By Katun</b> 680 g / Cartridge 8 Cartridges per Master Carton	NP 3030, NP 3050	<i>Priced per Cartridge, sold per Cartridge.</i>
1370A002AA	15017883 	<b>Black Toner</b> 350 g / Cartridge 12 Boxes (24 Cartridges) per Master Carton	NP 3325, NP 3825, NP 3825 II, NP 6825 DADF, NP 6826 DADF	<i>Priced per Box, 2 Cartridges per Box.</i>
1370A002AA	15017885	<b>Black Toner</b> <b>Access By Katun</b> 350 g / Cartridge 12 Boxes (24 Cartridges) per Master Carton	NP 3325, NP 3825, NP 3825 II, NP 6825 DADF, NP 6826 DADF	<i>Priced per Box, 2 Cartridges per Box.</i>
F41-8001-000	15017785 	<b>Black Toner</b> 750 g / Cartridge Equivalent to G-4 8 Cartridges per Master Carton	NP 4050, NP 4080, NP 6241	<i>Priced per Cartridge, sold per Cartridge.</i>
F41-8001-000	15017786	<b>Black Toner</b> <b>Access By Katun</b> 750 g / Cartridge 8 Cartridges per Master Carton	NP 4050, NP 4080, NP 6241	<i>Priced per Cartridge, sold per Cartridge.</i>
1371A002AA	15017873 	<b>Black Toner</b> 420 g / Cartridge 12 Boxes (24 Cartridges) per Master Carton	NP 4335, NP 4835, NP 4835 i, NP 6835 RDF	<i>Priced per Box, 2 Cartridges per Box.</i>
1371A002AA	15017875	<b>Black Toner</b> <b>Access By Katun</b> 420 g / Cartridge 12 Boxes (24 Cartridges) per Master Carton	NP 4335, NP 4835, NP 4835 i, NP 6835 RDF	<i>Priced per Box, 2 Cartridges per Box.</i>
F41-6202-000	15018145 	<b>Black Toner</b> 1500 g / Cartridge 8 Cartridges per Master Carton	NP 5020, NP 5060, NP 6150, NP 6650, NP 6850, NP 6880, NP 6885, NP 7050, NP 7550, NP 8070, NP 8530, NP 8570, NP 8580	<i>Priced per Cartridge, sold per Cartridge.</i>
1382A003AA	15013547	<b>Black Toner</b> <b>Original</b> 280 g / Cartridge NPG-11	NP 6012, NP 6112, NP 6212, NP 6512, NP 6612, NP 7130, NP 7130 F	
F41-0701-000	15013451	<b>Black Toner</b> <b>Original</b> 380 g / Cartridge NPG- 9	NP 6016, NP 6218, NP 6521, NP 6621	<i>Priced per Box, 2 Cartridges per Box.</i>
F41-9103-630	15017950 	<b>Black Toner</b> 500 g / Cartridge Equivalent to G-7 10 Cartridges per Master Carton	NP 6025, NP 6030	<i>Priced per Cartridge, sold per Cartridge.</i>
F41-9103-630	15017697	<b>Black Toner</b> <b>Original</b> 500 g / Cartridge	NP 6025, NP 6030, NP 6330	



OEM PN	KATUN PN	DESCRIPTION	MODEL NO.
-----------	-------------	-------------	--------------

## Toners/Toner Cartridges

1384A006AA	15019756 	<b>Black Toner</b> 540 g / Cartridge Equivalent to G-13, 13A, 13C 10 Cartridges per Master Carton	NP 6028, NP 6035, NP 6035 F	<i>Priced per Cartridge, sold per Cartridge.</i>
F42-2331-100	15017852 	<b>Black Toner</b> 1500 g / Cartridge Equivalent to G-14, 14A, 14C 6 Cartridges per Master Carton	NP 6045, NP 6251, NP 6260, NP 6350, NP 6360, NP 7500	<i>Priced per Cartridge, sold per Cartridge.</i>
1381A004AA	15017849 	<b>Black Toner</b> 1500 g / Cartridge Equivalent to G-10 6 Cartridges per Master Carton	NP 6050, NP 6050 ER	<i>Priced per Cartridge, sold per Cartridge.</i>
1381A004AB	15017849 	<b>Black Toner</b> 1500 g / Cartridge Equivalent to G-10 6 Cartridges per Master Carton	NP 6050, NP 6050 ER	<i>Priced per Cartridge, sold per Cartridge.</i>
1374A003AA	15017853 	<b>Black Toner</b> 1650 g / Cartridge Equivalent to G-3 10 Cartridges per Master Carton	NP 6060, NP 6062	<i>Priced per Cartridge, sold per Cartridge.</i>
F41-8801-010	15014626	<b>Black PC Toner Cartridge Original</b> 150 g / Cartridge	PC 710, PC 720, PC 730, PC 740, PC 745, PC 750, PC 775, PC 780	
7833A002	15024124	<b>Black Toner Cartridge Original</b> 1150 g / Cartridge	PC D 320, PC D 340	



## General Information

### Credit Terms and Ordering Information

#### Credit Terms

Standard credit terms are net-30-days from date of invoice. To open a net-30-day account, please contact the Katun Credit Department. Until your credit application is approved, orders will be shipped upon receipt of cash in advance or a confirmed, Sight Draft, or via C.O.D. (Nominal C.O.D. handling charges will apply.)

Katun offers a 3% cash-with-order (CWO) discount. Katun will calculate the 3% discount, promptly inform you of the total charges, and ship your order immediately upon receipt of your payment.

#### Place all orders with Katun (E.D.C.) B.V. via:

- **Telephone: 31(0) 183–696969**
- **Fax: 31(0) 183–629055**
- **E-mail: order@edc.katun.com**
- **Address:**

**Katun (E.D.C.) B.V.**  
**Edisonweg 44**  
**4207 HG Gorinchem**  
**The Netherlands**

Reference Katun part numbers on all orders.

Prices are in Euro, EX WORKS Gorinchem, The Netherlands.

Katun business hours are from 8:30 to 17.00 hours.

Katun has a € 350 minimum order. A € 35 charge will be added to orders under the minimum.

#### Wire transfer funds to:

ABN–AMRO Bank  
Daalsesingel 71  
Postbus 2059  
3500 GB Utrecht  
The Netherlands  
Account Number: 55 70 74 134  
Swift I.D.: ABN ANL 2A  
IBAN: NL51ABNA0557074134

## General Shipping Information and Product Return Policies

### Shipping and Handling

Katun can provide you with alternatives for shipping. We will attempt to select the most convenient and cost-effective carrier for you. However, if you have a preferred carrier, please inform your Katun Customer Service Representative.



## Central/Eastern Europe

Telephone: 31(0)183-696969

Fax: 31(0)183-629055

E-mail: [order@edc.katun.com](mailto:order@edc.katun.com)

Hazardous material shipments will be billed accordingly. A nominal handling charge is incorporated into our shipping costs.

## Product Return Policies

- Katun **must** preauthorize all returns. For return procedures and a return, contact the Customer Service Department at 31(0) 183–696969.
- Toner, toner cartridges, digital duplicator inks and masters, and thermal transfer ribbons with personalized labels cannot be returned to Katun for credit unless a valid warranty claim exists.
- Returns and refused shipments are subject to a minimum 10% restocking charge.
- With the exception of warranty claims, merchandise returned more than 90 days from the invoice date will not be accepted.
- Merchandise which has been written on, marked, relabeled, or placed in other than original Katun packaging will not be accepted.
- All warranty claims submitted to Katun *must* be accompanied by a completed Distributor Choice Warranty Claim Form (included in this catalog). Customers must indicate a warranty choice on the form:
  - (a) Technical Evaluation/ Replacement or technical Evaluation/ Credit: Ship the product and the completed form to:

**Katun (E.D.C.) B.V.**  
**Edisonweg 44**  
**4207 HG**  
**Gorinchem**  
**The Netherlands**
  - (b) Automatic Replacement: send the completed form to your customer service representative.



## Allgemeine Hinweise

### Zahlungsbedingungen und Bestellinformationen

Die übliche Zahlungsweise ist bar innerhalb von 30 Tagen ab Rechnungsdatum. Zur Eröffnung eines Kontos wenden Sie sich bitte an die Katun Kreditabteilung. Bis zur Gewährung Ihres Kredits erfolgt der Versand von Bestellungen bei Vorkasse oder bei Erhalt eines bestätigten, Sichtwechsel oder gegen Nachnahme (unter Berechnung einer geringen Nachnahmegebühr).

Katun gewährt 3 % Skonto für Barzahlung bei Bestellung. Katun wird den Skontobetrag errechnen, Ihnen den Gesamtbetrag mitteilen und Ihre Bestellung unverzüglich nach Erhalt Ihrer Zahlung zum Versand aufgeben.

Bitte richten Sie alle Bestellungen an Katun (E.D.C.) B.V. unter:

- **Telefon: 31 (0) 183–696969**
- **Fax: 31 (0) 183–629055**
- **E-mail: order@edc.katun.com**
- **Adresse:**

**Katun (E.D.C.) B.V.**  
**Edisonweg 44**  
**NL-4207 HG Gorinchem**  
**Niederlande**

Bitte bei allen Bestellungen die Katun Artikelnummern angeben. Preise verstehen sich in Euro, ab Werk Gorinchem, Niederlande.

Katun Geschäftszeit ist 8.30 - 17.00 Uhr. Für alle Bestellungen gilt ein Mindestbestellwert von € 350. Bei Bestellungen unter dem Mindestbestellwert wird ein Zuschlag von €35 berechnet.

#### Bankverbindung:

ABN AMRO Bank  
Daalsesingel 71  
Postbus 2059  
NL-3500 GB Utrecht  
Niederlande  
Kontonummer: 55 70 74 134  
Bankleitzahl: ABN ANL 2A  
IBAN: NL51ABNA0557074134

### Versand und Warenrücksendung

#### Bearbeitung und Versand

Katun bietet verschiedene Versandmethoden an. Wir bemühen uns, die für Sie günstigste und praktischste Versandart zu wählen. Falls Sie eine bestimmte Versandart/Firma vorziehen, teilen Sie dies bitte Ihrem Katun Repräsentanten mit.



## Central/Eastern Europe

Telephone: 31(0)183-696969

Fax: 31(0)183-629055

E-mail: [order@edc.katun.com](mailto:order@edc.katun.com)

Versandkosten für Gefahrgüter werden entsprechend berechnet. Eine geringe Bearbeitungsgebühr ist in unseren Versandgebühren enthalten.

## Warenrücksendung

- Nur von Katun vorher genehmigte Waren- rücksendungen könnenbearbeitet werden. Bitte lassen Sie sich vom Kundendienst unter der Telefonnummer 31 (0) 183-696969 genaue Anweisungen geben.
- Bei Warenrücksendungen werden 10 % Rücknahmegebühren in Abzug gebracht.
- Toner, Drucker-/Faxkartuschen, Tinten für digitale Duplikatoren sowie Thermo-Transfer-Bänder mit Firmenetiketten sind vom Umtausch ausgeschlossen, es sei denn, es liegt ein Garantiefall for.
- Ware, die nach Ablauf von 90 Tagen ab Rechnungsdatum zurückgeschickt wird, kann nicht zurückgenommen werden (mit Ausnahme von Reklamationen).
- Ware, deren Verpackung markiert, etikettiert oder beschriftet wurde, oder Ware ohne Originalverpackung kann nicht zurückgenommen werden.
- Alle Garantieansprüche müssen von einem ausgefüllten Händler -Garantieformular begleitet sein ( Formular in diesem Katalog enthaltrn). Geben Sie Ihren Regulierungswunsch auf dem Formular an:
  - (a) Technische Bewertung/Ersatz oder Technische Bewertung/Gutschrift: schicken Sie das Produkt und das vollständig ausgefüllte Formular an:

**Katun (E.D.C.) B.V.**  
**Edisonweg 44**  
**NL-4207 HG Gorinchem**  
**Niederlande**
  - (b) Ersatz ohne Bewertung: schicken Sie das vollständig ausgefüllte Formular an Ihren Ansprechpartner der Auftragsbearbeitung.

## DISTRIBUTOR CHOICE WARRANTY CLAIM FORM

*Please print all information. For prompt processing of your claim, please complete all sections. Your feedback is important to the ongoing improvement of Katun products. Thank you.*

### I. WARRANTY CHOICE

*Please check one. See Section 2 on reverse side for additional information.*

Technical Evaluation/Replacement       Technical Evaluation/Credit       Automatic Replacement

### II. CUSTOMER INFORMATION

Customer Number: \_\_\_\_\_ Date Shipped: \_\_\_\_\_

Company Name: \_\_\_\_\_ Delivery Date: \_\_\_\_\_

Address: \_\_\_\_\_

City: \_\_\_\_\_ State/Province: \_\_\_\_\_

Country: \_\_\_\_\_ Postal Code: \_\_\_\_\_

Your Name: \_\_\_\_\_ Title: \_\_\_\_\_

### III. PRODUCT INFORMATION

Katun PN	Quantity	Description	Serial/Lot Number
1) _____	_____	_____	_____
2) _____	_____	_____	_____
3) _____	_____	_____	_____
4) _____	_____	_____	_____
5) _____	_____	_____	_____

### IV. DETAILED REASON(S) FOR CLAIM

Provide specific information for each product claimed, explaining the reason for claim in as much detail as possible. Include machine models, machine log information, and copy/print counts. **See Section 3 on reverse side for additional specific requirements for photoreceptors.**

- 1) \_\_\_\_\_
- 2) \_\_\_\_\_
- 3) \_\_\_\_\_
- 4) \_\_\_\_\_
- 5) \_\_\_\_\_

#### **FOR KATUN USE ONLY**

Product Warranty Claim No.: \_\_\_\_\_ Pieces: \_\_\_\_\_  
Received By: \_\_\_\_\_ Date: \_\_\_\_\_

## Central/Eastern Europe

Telephone: 31(0)183-696969

Fax: 31(0)183-629055

E-mail: order@edc.katun.com

## PLEASE READ AND COMPLY WITH ALL THESE REQUIREMENTS TO EXPEDITE THE PROCESSING OF YOUR CLAIM.

### 1. General Instructions

A completed copy of this form must accompany all product warranty claims. Please indicate date of product delivery for determination of warranty coverage time period. *Your feedback is important to the ongoing improvement of Katun products. Please complete all sections on the reverse side.*

### 2. Distributor Choice Warranty Claim Options

Please indicate your choice of Technical Evaluation/Replacement, Technical Evaluation/Credit, or Automatic Replacement. **NOTE:** Automatic Replacement claims must be filed within 90 days of product delivery date, and must not exceed US\$500/€ 550.

If no choice is indicated:

- (a) If product is included with this form, this claim will be treated as Technical Evaluation/Replacement.
- (b) If no product is included with this form, and the claim is less than US\$500/€ 550, this claim will be treated as Automatic Replacement.
- (c) If no product is included with this form, and the claim is more than US\$500/€ 550, the claim is invalid.

### 3. Specific Requirements

If damage (for example, a chip or scratch on a photoreceptor) is noted "out-of-box," **DO NOT INSTALL THE PRODUCT.** No copy/print samples are required. Installing a product with out-of-box damage could void the warranty.

*Include applicable copy/print samples with all claims.* If a photoreceptor is suspected to be defective after machine installation, please attach to this form the copy/print samples indicated below. This will allow a thorough evaluation of the claim. Ensure that neither the form nor copy/print samples will contact the photoreceptor surface during shipment.

**FOR PHOTORECEPTORS USED IN COPIERS,** include:

- (a) Three "sky shot" (open platen; black) copies;
- (b) Three white copies; and
- (c) Three copies of a test pattern.

**NOTE:** If the defect is not visible on the copies indicated above, please attach three copies which clearly show the defect.

**FOR PHOTORECEPTORS USED IN PRINTERS AND PLAIN PAPER FACSIMILES,** include three prints which clearly show the defect.

**IMPORTANT:** The Katun product warranty does not cover damage by operator, technician, or machine (including rotational scratches, gouges, scuff marks, or line scratches).

### 4. Shipping Instructions

**ALL PRODUCT RETURNS MUST BE PROPERLY PACKAGED.** This includes packaging in the correct individual product box and in a second container with adequate protective packaging material. This is required by all carriers.

**NOTE:** Products damaged in transit to Katun due to inadequate packaging cannot be covered by the Katun product warranty, and will be returned.

**Ship Technical Evaluation claims, freight prepaid, to the address specifically indicated for this purpose in the "General Information" section of the Katun On-Line Catalogue and current printed catalogues.** Katun cannot accept responsibility for product warranty claims sent to any other address. **Send Automatic Replacement Claims to your Katun Customer Service Representative.**

## HÄNDLER-GARANTIEFORMULAR

*Das Formular bitte in Druckschrift ausfüllen. Um eine umgehende Bearbeitung Ihrer Reklamation zu ermöglichen, tragen Sie bitte alle Angaben ein.*

*Ihr Feedback trägt zur weiteren Verbesserung von Katun-Produkten bei. Vielen Dank.*

### I. REGULIERUNGSWUNSCH

*Bitte nur einen ankreuzen. Weitere Informationen finden Sie in Abschnitt 2 auf der Rückseite.*

Technische Bewertung/Ersatz     Technische Bewertung/Gutschrift     Ersatz ohne Bewertung

### II. KUNDENINFORMATIONEN

Kunden-Nr.: \_\_\_\_\_ Versanddatum: \_\_\_\_\_

Firmenname: \_\_\_\_\_ Lieferdatum: \_\_\_\_\_

Straße: \_\_\_\_\_

Postleitzahl: \_\_\_\_\_ Ort: \_\_\_\_\_

Land: \_\_\_\_\_

Ihr Name: \_\_\_\_\_ Titel/Funktion: \_\_\_\_\_

### III. PRODUKTINFORMATIONEN

Katun-Artikel-Nr.	Menge	Bezeichnung	Serien-/Lotnummer
1) _____	_____	_____	_____
2) _____	_____	_____	_____
3) _____	_____	_____	_____
4) _____	_____	_____	_____
5) _____	_____	_____	_____

### IV. AUS WELCHEM GRUND REKLAMIEREN SIE DIE WARE?

Machen Sie bitte zu jedem reklamierten Artikel so ausführliche und genaue Angaben wie möglich. Des weiteren benötigen wir Angaben zum Gerätemodell, eine Kopie des Bordbuches sowie Informationen bezüglich der Anzahl der erstellten Kopien/Ausdrucke des Produktes. **Bitte beachten Sie Punkt 3 auf der Rückseite mit wichtigen Informationen zur Reklamation von Fotorezeptoren.**

1) \_\_\_\_\_

2) \_\_\_\_\_

3) \_\_\_\_\_

4) \_\_\_\_\_

5) \_\_\_\_\_

#### **NUR FÜR DEN INTERNEN GEBRAUCH**

Reklamations-Nr.: \_\_\_\_\_ Stückzahl: \_\_\_\_\_

Entgegengenommen von: \_\_\_\_\_ Eingangsdatum: \_\_\_\_\_



## Central/Eastern Europe

Telephone: 31(0)183-696969

Fax: 31(0)183-629055

E-mail: order@edc.katun.com

## BITTE BEACHTEN SIE FOLGENDE HINWEISE, UM DIE BEARBEITUNG IHRER REKLAMATION ZU BESCHLEUNIGEN.

### 1. Allgemeine Hinweise

Verwenden Sie diesen Mängelbericht bei allen Reklamationen. Geben Sie zur Bestimmung der Garantiefrist bitte das Lieferdatum des Produktes an. *Ihr Feedback trägt zur weiteren Verbesserung von Katun-Produkten bei. Bitte tragen Sie alle Angaben auf der Rückseite vollständig ein.*

### 2. Händler-Garantieoption

Geben Sie bitte Ihren Regulierungswunsch an (Technische Bewertung/Ersatz, Technische Bewertung/Gutschrift oder Ersatz ohne Bewertung.) **BITTE BEACHTEN:** Reklamationen ohne Bewertung müssen innerhalb von 90 Tagen nach dem Lieferdatum des Produktes geltend gemacht werden und dürfen einen Wert von USD 500/Euro 550 nicht überschreiten.

Wenn keine Wahl getroffen wurde:

- (a) Wenn diesem Formular das Produkt beigelegt wurde, wird diese Reklamation als Technische Bewertung/Ersatz bearbeitet.
- (b) Wenn diesem Formular kein Produkt beigelegt wurde und der Wert der Reklamation weniger als USD 500/ Euro 550 beträgt, wird diese Reklamation als Ersatz ohne Bewertung bearbeitet.
- (c) Wenn diesem Formular kein Produkt beigelegt wurde und der Wert der Reklamation mehr als USD 500/ Euro 550 beträgt, besteht kein Anspruch auf Reklamation.

### 3. Spezielle Anforderungen

Wenn Schäden (z.B. Splitter oder Kratzer an einem Fotorezeptor) bereits „beim Auspacken“ festgestellt werden, dann **INSTALLIEREN SIE DAS PRODUKT NICHT.** Testkopien sind nicht erforderlich. Die Installation eines Produktes mit bereits bestehendem Schaden könnte zum Erlöschen Ihrer Garantieansprüche führen.

*Fügen Sie allen Reklamationen entsprechende Testkopien bei.* Wenn ein Fotorezeptor nach der Installation einen Defekt aufzuweisen scheint, legen Sie diesem Formular bitte die nachstehend beschriebenen Testkopien bei, um eine genaue Beurteilung der Mängel zu ermöglichen. Das Formular sowie die Testkopien dürfen bei der Rücksendung auf keinen Fall mit der Oberfläche des Fotorezeptors in Berührung kommen.

**FÜR FOTOREZEPTOREN, DIE IN KOPIERERN BENUTZT WURDEN,** folgende Testkopien beilegen:

- (a) 3 schwarze Kopien (bei offener Vorlagenglas-Abdeckung),
- (b) 3 weiße Kopien und
- (c) 3 Testkopien (vom Testbogen).

**BITTE BEACHTEN:** Ist der Defekt auf diesen Mustern nicht sichtbar, legen Sie bitte 3 Kopien bei, auf denen er deutlich zu erkennen ist.

**FÜR FOTOREZEPTOREN, DIE IN DRUCKERN UND NORMALPAPIER-FAXGERÄTEN BENUTZT WURDEN,** legen Sie bitte 3 Kopien bei, auf denen der Defekt deutlich zu erkennen ist.

**WICHTIG:** Schäden, die durch falsche Bedienung des Endanwenders, durch den Techniker oder das Gerät verursacht wurden (d. h. umlaufende Kratzer, Streifen, Abrieb oder querlaufende Kratzer), sind von der Katun Qualitätsgarantie ausgeschlossen.

### 4. Versandrichtlinien

ALLE TEILE, DIE AN UNS ZURÜCKGESANDT WERDEN, MÜSSEN SACHGEMÄSS VERPACKT SEIN, d. h. in dem entsprechenden Einzelkarton und einem zweiten Karton mit entsprechendem Verpackungsmaterial. Dies betrifft jeglichen Transportweg!

**BITTE BEACHTEN:** Teile, die nicht sachgemäß verpackt werden und uns aus diesem Grunde defekt erreichen, sind von der Katun-Qualitätsgarantie ausgeschlossen und werden nicht angenommen.

**Schicken Sie Ihre Reklamation zur technischen Bewertung (frachtfrei) an die für diese Zwecke im Katun-Online-Katalog und dem gültigen regulären Katalog unter den „allgemeinen Hinweisen“ angegebene Adresse.** Katun übernimmt keinerlei Verantwortung für Reklamationen, die an eine andere Adresse als die oben genannte geschickt werden. **Schicken Sie Reklamation zum Ersatz ohne Bewertung an Ihren Katun-Ansprechpartner.**

